

Model Selection Guide for Timers

H3 and H5 Series



Table of Contents

Basic Selection Information for Timers

Timer's Advantage	3
Basic Configuration of a Timer	4
Basic Operation of a Timer	5

Model Selection Guide for Timers to fit your need

Recommended Timer Table	11
Minimizing Mounting Space in Control Panels	12
Getting Set Value Accuracy	15
Frequently Changing the Settings	16
One Model Choice for Various Power Supply Voltages	17
When the Application Life Expectancy Is Extremely Long	18
Installing Many Timers Together	19
When Measurement Conditions Must Be Checked Frequently Onsite	20
Avoiding Unapproved Changes to Settings	21
Mounting on a PCB	22
Designing for High Resistance to Vibration	23
Using Star-delta Starting for a 3-phase Motor	24
Setting ON and OFF Times Separately	25
Using OFF-delay Operation for Power Interruptions	26

Product Overview

Overview with Basic Functions/Specifications	27
--	----

Basic Selection Information for Timers

Timer's Advantage

Timers are one of the simplest types of control components. If you understand their advantage and the differences between them and PLCs, you will be able to suitably design your applications.

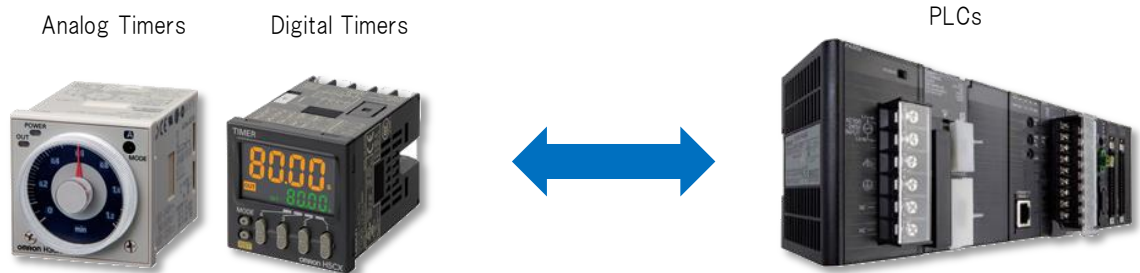

- The time can be set directly without using other setup tool like a software.
- The set value can be visually checked onsite.
- They are easy to replace if Product failure happens.
- It is easy to understand the time sequence only by diagram.
- The time setting is possible without a power supply input.
(For Analog Timers)
- There is no setting error by the distinct operators as well as PLCs.
(For Digital Timers)

Basic Selection Information for Timers

Basic Configuration of a Timer

A timer is a control device that outputs a signal at a preset time after an input signal is received.

■ Basic Configuration

- (1) The electronic circuits receive an input and measure time.
- (2) The operating portion sets the time.
- (3) The relay portion outputs a signal.

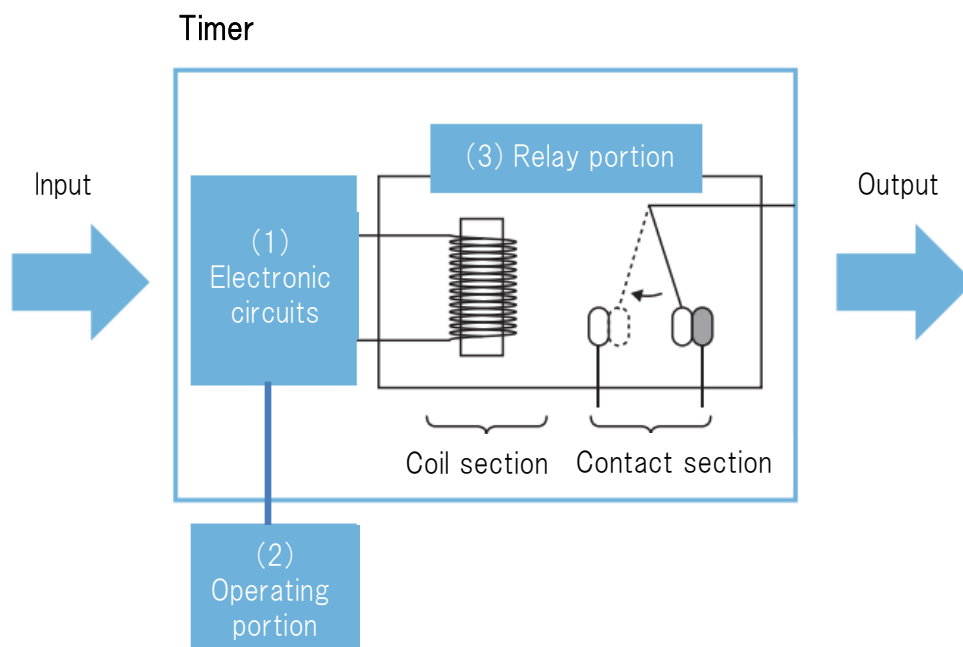

Basic Selection Information for Timers

Basic Operation of a Timer

Starting Methods

There are two starting methods. With the first method, the power supply input becomes a trigger to start timing. With the other method, an independent input signal port from the power supply is provided and the signal input becomes a trigger to start timing.

(1) Power ON/OFF Starting Method

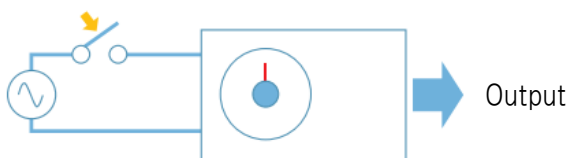

*Timing is reset when the power supply is turned OFF.

(2) Signal ON/OFF Starting Method

Voltage Input

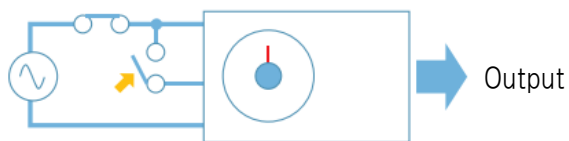

*Timing is reset through a reset input terminal.

Non-voltage Input

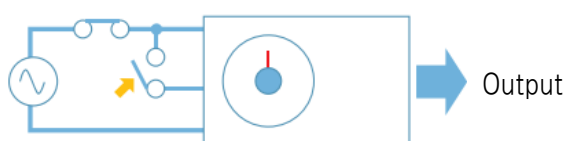

*Timing is reset through a reset input terminal.

In What Case Is This Used?

- (1) First: The equipment is turned ON
- (2) Second: an operation panel or PLC are turned ON
- (3) Third: The sensors are turned ON

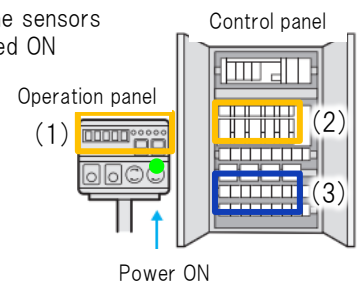

Start up Sequence operation by Timers.
Different time settings make different start up time by turning on the equipment(Power ON)..

In What Case Is This Used?

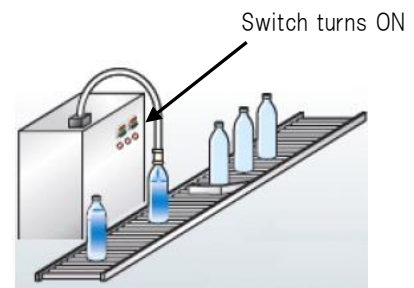

A switch is turned ON with a pushbutton and then a bottle is filled with liquid for a specific period of time by a Timer.

Basic Selection Information for Timers

Basic Operation of a Timer

■ Operating Modes

The operating mode tells you how a signal is output (how a relay operates) when the set time is reached. There are various operating modes. Several typical ones are described here.

1. Power ON-delay

Timing starts when the power supply is input and an output turns ON after the set time elapses.

Timing Chart

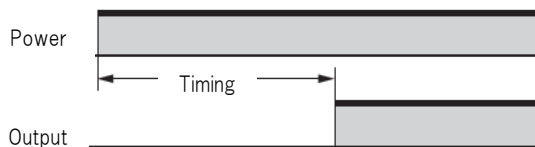

2. Signal ON-delay

Timing starts when a signal is input and an output turns ON after the set time elapses.
(Operation is reset with an input to a reset terminal.)

Timing Chart

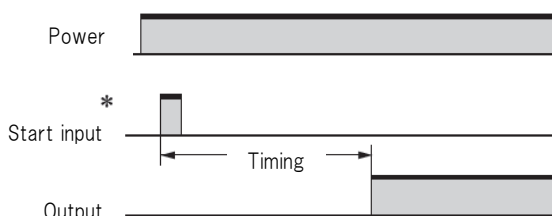

*Start input is invalid while the Timer is in operation.

In What Case Is This Used?

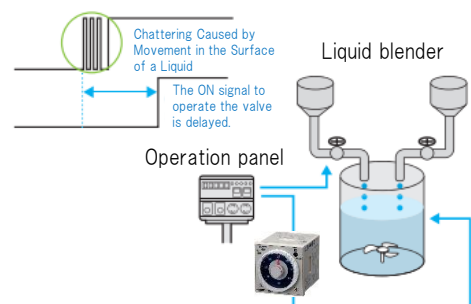

The chattering period of the liquid surface at the detection threshold value can be canceled by On delay timer and the valve is controlled properly.

When Is This Used?

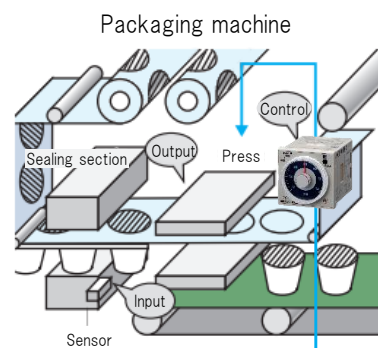

A sensor detects a package in the first stage. The time the package is fed on the conveyor is measured and the press is operated to apply the seal.

Basic Selection Information for Timers

Basic Operation of a Timer

3. Signal OFF-delay

With this mode, the output turns ON when the input turns ON. Then, when the input turns OFF, timing starts and the output is turned OFF after the set time elapsed.

Timing Chart

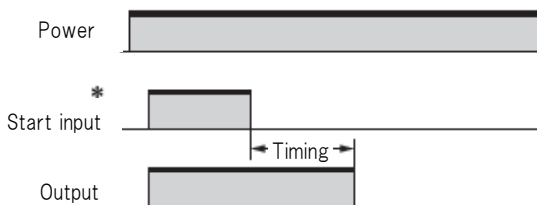

*Start input is valid while the Timer is in operation.

4. Interval

Timing starts when a signal turns ON and an output turns OFF after the set time elapses.

Timing Chart

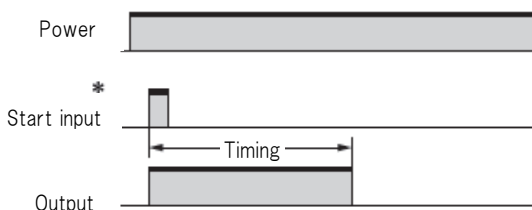

*Start input is valid while the Timer is in operation.
(The previous start input is canceled.)

5. Flicker

Timing starts when a signals turns ON and an output repeatedly turns ON and OFF for the set times.

Timing Chart

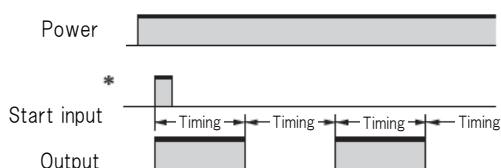

*Start input is invalid while the Timer is in operation.

In What Case Is This Used?

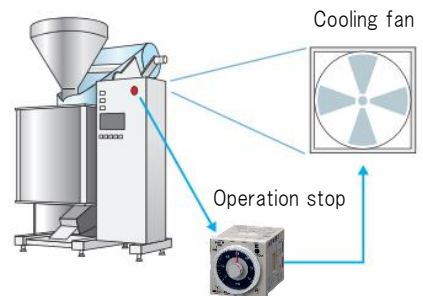

The cooling fan in the control panel continues to operate for a specific period of time even after equipment operation has stopped.

In What Case Is This Used?

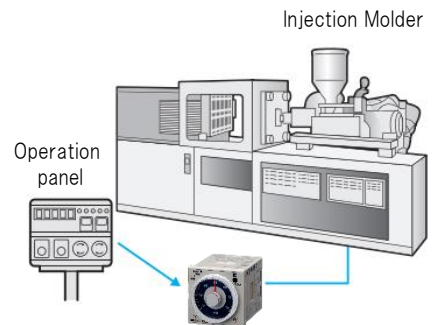

A mold is filled with plastic material, it is cooled for a specific time, and then operation stops.

In What Case Is This Used?

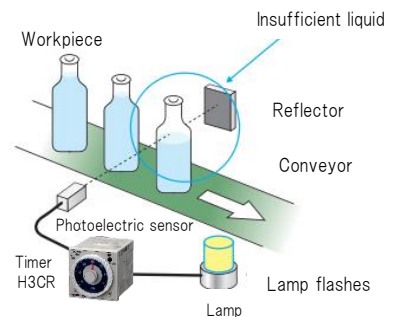

A photoelectric sensor check the level of the liquid. If it is below a specific level, an alarm lamp is operated.

Basic Selection Information for Timers

Basic Operation of a Timer

■ Output Methods (Control Methods)

Timers are available with relay outputs or transistor outputs.

Output types	Features
Contact (relay) output	Relatively large currents can be switched. Either AC or DC load voltages can be used.
Transistor output	There are no contacts, so high-speed, high-frequency switching is possible. Only DC can be switched and the capacity is lower than for a relay output.

Contact (relay) outputs are available in DPDT, 4PDT, and other forms. These are used often when plural loads control is necessary.

H3Y-2-B (DPDT)

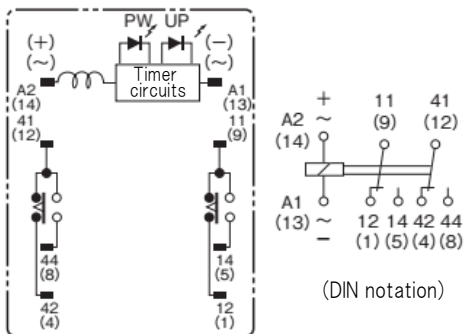

H3Y-4-B (4PDT)

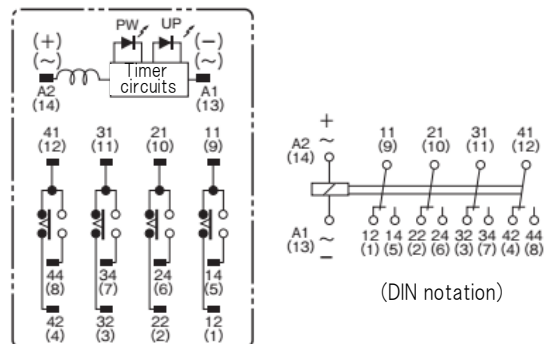

One application for DPDT output of Timer

A mold is filled with plastic material, it is cooled for a specific time, and then operation stops.

An indicator is lit on the operation panel as soon as operation stops.

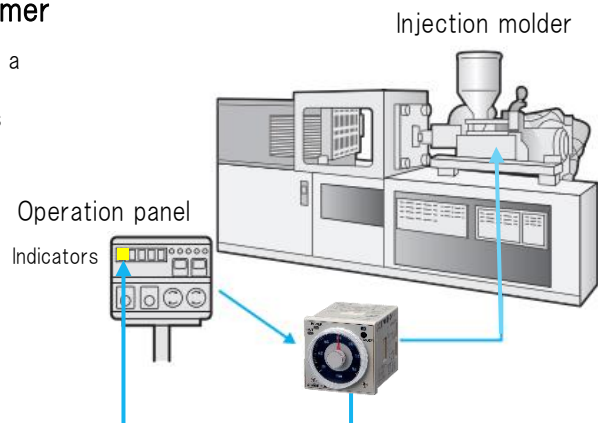

Basic Selection Information for Timers

Basic Operation of a Timer

■ Other Items That Need to Be Considered in Selection

• In The Case of Contact (Relay) Outputs

Output specifications (example):

250 VAC/30 VDC 5 A
125 VDC 0.15 A
resistive load ($\cos \phi = 1$)
The minimum applicable load is 10 mA at 5 VDC
(failure level: P).

Life-test Curve (Reference)

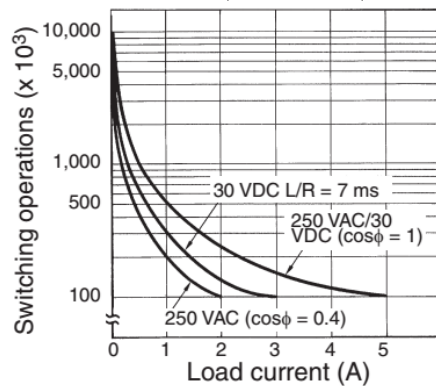

Reference: A maximum current of 0.15 A can be switched at 125 VDC ($\cos \phi = 1$) and a maximum current of 0.1 A can be switched at 125V DC and L/R = 7ms. In both cases, a life of 100,000 operations can be expected. The minimum applicable load is 10 mA at 5 VDC (failure level: P).

1. Confirm that the voltage, type of voltage (AC or DC), and the maximum contact current are satisfied.
2. The specifications for operating an inductive load are different from those for a resistive load. Check specifications on service life curves or other information in datasheets.
3. Check the minimum applicable load in the ratings table. There are restrictions in how small of a current can be switched.

• Transistor Outputs

Output specifications (example): Transistor output:
NPN open-collector
30 VDC max. 100 mA max.
residual voltage: 2 V max.

1. There are NPN (sinking) and PNP (sourcing) transistor outputs.
2. Confirm that the voltage and type of voltage satisfy the transistor specifications.
3. When the transistor is ON, the voltage is not 0 V, and there is residual voltage. Confirm that this residual voltage will not cause false operation of the load.

Basic Selection Information for Timers

Basic Operation of a Timer

■ Time-limit Contacts and Instantaneous Contacts

• Time-limit Contacts

These contacts operate according to the timing operation of the Timer.

• Instantaneous Contacts

These contacts are not affected by the timing operation of the Timer, i.e., they operate when the power supply to the Timer is turned ON.

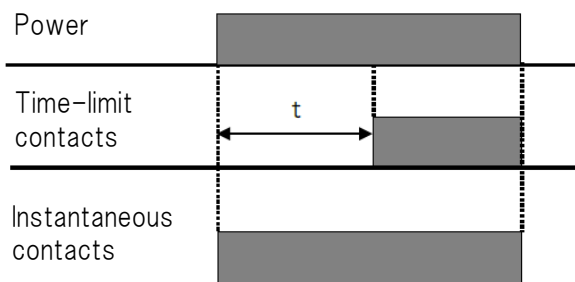

■ Time Setting Range

Make sure if the Timer supports the time range that you need to set. Some Timers allow you to change the scale numbers or time unit to cover a wide range of times.

Time Ranges (Example)

Maximum scale number	Time unit	sec (seconds)	× 10s (seconds)	min (minutes)	× 10m (minutes)	hrs (hours)	× 10h (hours)
1.2	Time setting range	0.05 to 1.2	1.2 to 12	0.12 to 1.2	1.2 to 12	0.12 to 1.2	1.2 to 12
3		0.3 to 3	3 to 30	0.3 to 3	3 to 30	0.3 to 3	3 to 30
12		1.2 to 12	12 to 120	1.2 to 12	12 to 120	1.2 to 12	12 to 120
30		3 to 30	30 to 300	3 to 30	30 to 300	3 to 30	30 to 300



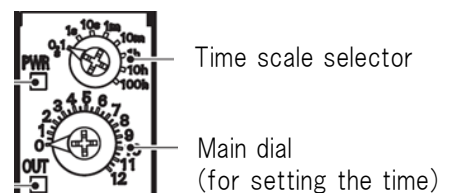





1. Confirm that you can select the time that you need to set.
2. Chose the Time scale which the set value is closest to the maximum scale value. This will increase the accuracy.



Model Selection Guide for Timers to fit your need

Recommended Timer Table

The following table gives the recommended Timer models according to the needs.
The features of each Timer are introduced on the reference pages provided in the table.

		Recommended models								
		H3CR	H3Y-B /H3YN-B	H3RN-B	H3DT	H3DK	H3DS	H3FA	H5CX	H5CZ
Needs	Page									
Minimizing mounting space in Control panel when many components are mounted to the same track	P12		No.3	No.2	No.1					
Minimizing mounting space in Control panel by reducing the distance between upper and lower ducts	P13	No.1	No.2				No.3			
Minimizing mounting space in Control panel when the control panel is thin and the shorter depth of product is necessary	P14			No.2			No.1			
Getting set value accuracy	P15								No.1	No.2
Frequently changing the settings	P16	No.1	No.2						No.3	
One model choice for various power supply voltages	P17	No.2			No.1					
When the application life expectancy is extremely long	P18	No.2	No.1	No.3						
Installing many Timers together	P19		No.1	No.2						
When measurement conditions must be checked frequently onsite	P20	No.1							No.2	
Avoiding unapproved changes to settings	P21						No.1		No.2	
Mounting on a PCB	P22		No.1					No.2		
Designing for high resistance to vibration	P23		No.1							
Using Star-delta starting for a 3-phase motor	P24	No.1			No.2					
Setting ON and OFF Times separately	P25	No.1			No.2				No.3	
Using OFF-delay operation for power interruptions	P26	No.1			No.2					

Model Selection Guide for Timers to fit your need

Minimizing Mounting Space in Control Panels

When many components are mounted to the same track

Choice No. 1

H3DT Series

The Timers are only 17.5 mm wide, require no space on either side (i.e., they can be mounted side by side), and can be used at an ambient temperature of 55°C.



Model Overview

Series	Operating modes	Time ranges	Supply voltages	Output types
H3DT-N H3DT-L	Multi-mode · ON-delay · Flicker · Interval · Signal ON/OFF-delay · Signal OFF-delay · One shot · Cumulative	8 range settings Maximum range: 0.1 s to 1,200 h	24 to 240 VAC/DC	2 specifications · DPDT relay · SPDT relay
H3DT-A	Power ON-delay			SPDT relay
H3DT-F	Multi-mode (twin time setting) · Flicker OFF start · Flicker ON start			SPDT relay
H3DT-H	Power-OFF delay	2 range settings 2 specifications Maximum range: · 0.1 to 12 s · 1 to 120 s	3 specifications · 100 to 120 VAC · 200 to 240 VAC · 24 to 48 VAC/DC	SPDT relay
H3DT-G	Star-delta timer	8 range settings Maximum range: 1 s to 120 s	24 to 240 VAC/DC	SPDT relay x 2 (one for star operation/one for delta operation)

Choice No. 2

H3RN-B (H3RN) Series

Combination with a P2RF-□□-PU Socket (width: 15.5 mm), enables mounting with no space on either side of the Socket (i.e., side by side) for usage at an ambient temperature of 55°C.

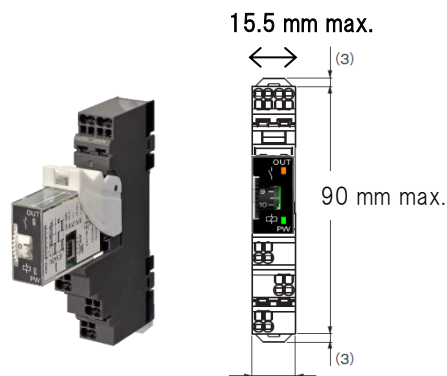

Choice No. 3

H3Y-B/H3YN-B (H3Y/H3YN) Series

Combination with a PYF-□□-PU-L Socket (width: 31 mm), enables mounting with no space on either side of the Socket (i.e., side by side) for usage at an ambient temperature of 55°C.

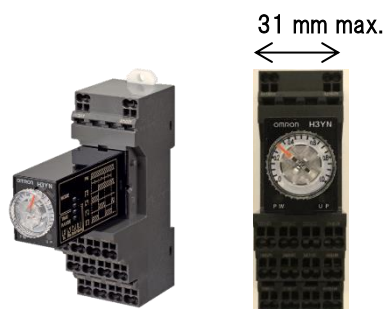

Model Selection Guide for Timers to fit your need

Minimizing Mounting Space in Control Panels

Reducing The Distance Between Upper and Lower Ducts

Choice No. 1

H3CR Series

The product height is 74 mm max. when mounted on a P2CF-□□ Socket.

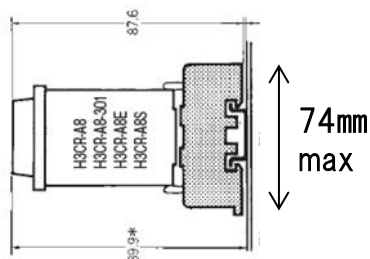

Model Overview

Series	Operating modes	Time ranges	Supply voltages	Output types	Recommended Sockets
H3CR-A	Multi-mode, 2 specifications ·ON-delay ·Flicker ·Interval ·Signal ON/OFF-delay ·Signal OFF-delay ·One shot	20 range settings 2 specifications Maximum range: ·0.05 s to 300 h ·0.1 s to 600 s	2 specifications ·100 to 240 VAC or 100 to 125 VDC ·24 to 48 VAC or 12 to 48 VDC	2 specifications ·DPDT relay ·One transistor output	P2CF-08 P2CF-11
H3CR-F	2 specifications (twin time setting) ·Flicker OFF start ·Flicker ON start	20 range settings Maximum range: 0.05 s to 300 h		DPDT relay	
H3CR-H	Power-OFF delay	4 range settings 2 specifications Maximum range: ·0.05 to 12 s ·0.05 to 12 min	5 specifications ·100/110/120 VAC ·200/220/240 VAC ·24 VAC/DC ·48 VDC ·100 to 125 VDC	2 specifications ·DPDT relay ·SPDT relay	P2CF-08 P2CF-11
H3CR-G	Star-delta timer	4 range settings Maximum range: 0.5 s to 120 s	2 specifications ·100/110/120 VAC ·200/220/240 VAC	2 specifications ·SPST-NO relay (star operation circuit) SPST-NO relay (delta operation circuit) ·SPST-NO relay (star operation circuit) SPST-NO relay (delta operation circuit) SPST-NO relay (instantaneous output)	P2CF-08

Choice No. 2

H3Y-B/H3YN-B (H3Y/H3YN) Series

The product height is 76 mm max. when mounted on a PYF□□A Socket. When used with the Socket, no space is required on either side (i.e., they can be mounted side by side) and usage is possible at an ambient temperature of 55°C.

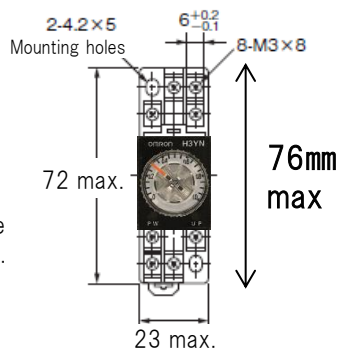

Choice No. 3

H3DS Series

Slim Timers with a height of 80 mm and width of 17.5 mm.

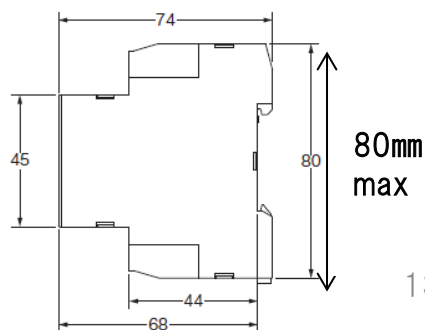

Model Selection Guide for Timers to fit your need

Minimizing Mounting Space in Control Panels

When The Control Panel is Thin and The Shorter Depth of Product is Necessary.

Choice No. 1

H3DS Series

The Timer depth is 78 mm max. for mounting in shallow control panels.

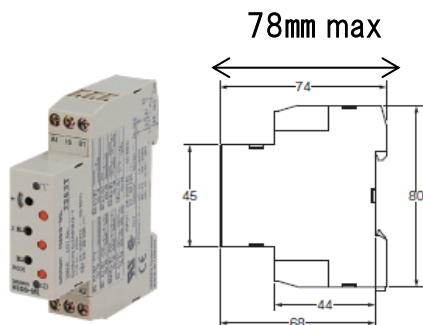

Model Overview

Series	Operating modes	Time ranges	Supply voltages	Output types
H3DS-ML	Multi-mode · ON-delay · Flicker · Interval · Signal ON/OFF-delay · Signal OFF-delay · One shot	7 range settings Maximum range: 0.1 s to 120 h	24 to 230 VAC or 24 to 48 VDC	SPDT relay
H3DS-SL	Multi-mode · ON-delay · Flicker · Interval · One shot			
H3DS-AL	Power ON-delay			

Choice No. 2

H3RN-B (H3RN) Series

The Timer depth is 82.8 mm max. when mounted to the P2RF-□□-PU Socket to enable mounting in shallow control panels.

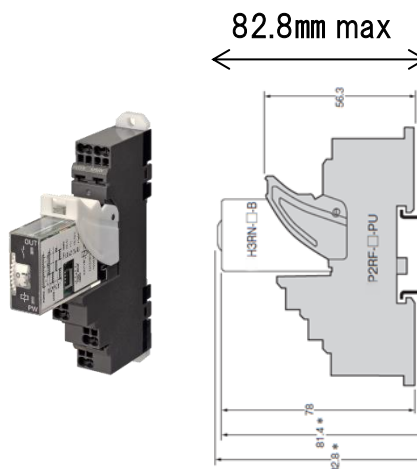

Model Selection Guide for Timers to fit your need

Getting Set Value Accuracy

Choice No. 1

H5CX Series

A digital setting eliminates differences in settings a setting error by the distinct operators



Model Overview

Series	Operating modes	Time ranges	Supply voltages	Output types
H5CX-A with 4-digit display	Multi-mode · Signal ON-delay x 2 · Power ON-delay x 2 · Flicker x 2 · Signal OFF-delay · Interval · Cumulative · ON/OFF-duty-adjustable · Stopwatch	10 range settings Maximum range: 0.001 s to 9,999 h	2 specifications · 100 to 240 VAC · 24 VAC or 12 to 24 VDC	3 specifications · SPDT relay · DPDT relay · Transistor
H5CX-L with 4-digit display	Multi-mode · Power ON-delay x 1 · Flicker x 1 · Interval · ON/OFF-duty-adjustable · Twine timer flicker x 2	4 range settings Maximum range: 0.001 s to 9,999 h	24 VAC or 12 to 24 VDC	Transistors x 2
6-digit display	Multi-mode · Signal ON-delay · Cumulative	4 range settings Maximum range: 0.001 s to 9,999 h	24 VAC or 12 to 24 VDC	Transistors x 2

Up/down seesaw key to set each digit
(6-digit display type has only Up keys for each digit.)

Line-up of On-Panel Mounting Accessories

Timers with 4-digit Display



Timers with 6-digit Display

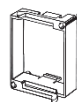

On-Panel Mounting Adapter
Y92F-30

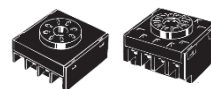

Sockets
P3G-081 P3GA-11



Hard Cover
Y92A-48B



Soft Cover
Y92A-48F1



Waterproof Packing
Y92S-29

Choice No. 2

H5CZ Series

Digital Timers using LCDs.



Model Selection Guide for Timers to fit your need

Frequently Changing the Settings

Choice No. 1

H3CR Series

A large time setting dial and scale intervals make time adjustment easy and enable changing the setting without any tools. Using the Y92F-30 Adapter enables On-panel mounting.



Easy-to-Use Dial Setting

Model Overview

Series	Operating modes	Time ranges	Supply voltages	Output types	Recommended Sockets
H3CR-A	Multi-mode, 2 specifications · ON-delay · Flicker · Interval · Signal ON/OFF-delay · Signal OFF-delay · One shot	20 range settings 2 specifications Maximum range: · 0.05 s to 300 h · 0.1 s to 600 s	2 specifications · 100 to 240 VAC or 100 to 125 VDC · 24 to 48 VAC or 12 to 48 VDC	2 specifications · DPDT relay · One transistor output	P2CF-08 P2CF-11
H3CR-F	2 specifications (twin time setting) · Flicker OFF start · Flicker ON start	20 range settings Maximum range: 0.05 s to 300 h		DPDT relay	
H3CR-H	Power-OFF delay	4 range settings 2 specifications Maximum range: · 0.05 to 12 s · 0.05 to 12 min	5 specifications · 100/110/120 VAC · 200/220/240 VAC · 24 VAC/DC · 48 VDC · 100 to 125 VDC	2 specifications · DPDT relay · SPDT relay	P2CF-08 P2CF-11
H3CR-G	Star-delta timer	4 range settings 2 specifications Maximum range: 0.5 s to 120 s	2 specifications · 100/110/120 VAC · 200/220/240 VAC	2 specifications · SPST-NO relay (star operation circuit) · SPST-NO relay (delta operation circuit) · SPST-NO relay (star operation circuit) · SPST-NO relay (delta operation circuit) · SPST-NO relay (instantaneous output)	P2CF-08

Choice No. 2

H3Y-B/H3YN-B (H3Y/H3YN) Series

Plug-in Timer using a small time setting dial.



Choice No. 3

H5CX Series

Settings are easy to change with the front panel keys. On-Panel mounting is possible.



Up/down seesaw key to set each digit (6-digit display type has only Up keys for each digit.)

Timers with 4-digit Display

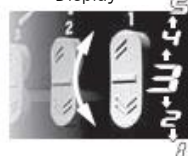

Timers with 6-digit Display

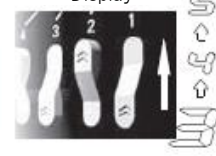

Model Selection Guide for Timers to fit your need

One Model Choice for Various Power Supply Voltages

Choice No. 1

H3DT Series

These Timers support a wide power supply voltage range from 24 VAC/DC to 240 VDC.



Model Overview

Series	Operating modes	Time ranges	Supply voltages	Output types
H3DT-N H3DT-L	Multi-mode · ON-delay · Flicker · Interval · Signal ON/OFF-delay · Signal OFF-delay · One shot · Cumulative	8 range settings Maximum range: 0.1 s to 1,200 h	24 to 240 VAC/DC	2 specifications · DPDT relay · SPDT relay
H3DT-A	Power ON-delay			SPDT relay
H3DT-F	Multi-mode (twin time setting) · Flicker OFF start · Flicker ON start			
H3DT-H	Power-OFF delay	2 range settings 2 specifications Maximum range: · 0.1 to 12 s · 1 to 120 s	3 specifications · 100 to 120 VAC · 200 to 240 VAC · 24 to 48 VAC/DC	SPDT relay
H3DT-G	Star-delta timer	8 range settings Maximum range: 1 s to 120 s	24 to 240 VAC/DC	SPDT relay x 2 (one for star operation/one for delta operation)

Choice No. 2

H3CR Series

A high-voltage input (100 to 240 VAC/100 to 125 VDC) or low-voltage input (24 to 48 VAC /12 to 48 VDC) are selectable for the power supply voltage specifications, .



Model Overview

Series	Operating modes	Time ranges	Supply voltages	Output types	Recommended Sockets
H3CR-A	Multi-mode, 2 specifications · ON-delay · Flicker · Interval · Signal ON/OFF-delay · Signal OFF-delay · One shot	20 range settings 2 specifications Maximum range: · 0.05 s to 300 h · 0.1 s to 600 s	2 specifications · 100 to 240 VAC or 100 to 125 VDC · 24 to 48 VAC or 12 to 48 VDC	2 specifications · DPDT relay · One transistor output	P2CF-08 P2CF-11
H3CR-F	2 specifications (twin time setting) · Flicker OFF start · Flicker ON start	20 range settings Maximum range: 0.05 s to 300 h		DPDT relay	
H3CR-H	Power-OFF delay	4 range settings 2 specifications Maximum range: · 0.05 to 12 s · 0.05 to 12 min	5 specifications · 100/110/120 VAC · 200/220/240 VAC · 24 VAC/DC · 48 VDC · 100 to 125 VDC	2 specifications · DPDT relay · SPDT relay	P2CF-08 P2CF-11
H3CR-G	Star-delta timer	4 range settings Maximum range: 0.5 s to 120 s	2 specifications · 100/110/120 VAC · 200/220/240 VAC	2 specifications · SPST-NO relay (star operation circuit) SPST-NO relay (delta operation circuit) · SPST-NO relay (star operation circuit) SPST-NO relay (delta operation circuit) SPST-NO relay (instantaneous output)	P2CF-08

Model Selection Guide for Timers to fit your need

When the Application Life Expectancy Is Extremely Long

Choice No. 1

H3Y-B/H3YN-B (H3Y/H3YN) Series

The Plug-in Socket lets you replace the Timer without rewiring to reduce wiring work.

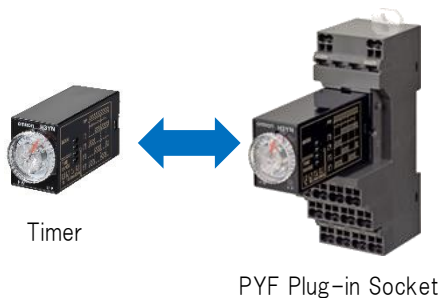

Model Overview

Series	Operating modes	Time ranges	Supply voltages	Output types	Recommended Sockets
H3Y-B	<ul style="list-style-type: none"> Power ON-delay 	13 range settings Maximum range: 0.04 s to 3 h	6 specifications · 100 to 120 VAC · 200 to 240 VAC · 100 to 110 VDC · 12 VDC · 24 VDC · 48 VDC	2 specifications · DPDT relay · 4PDT relay	PYF-08-PU-L PYF-14-PU-L
H3YN-B	<ul style="list-style-type: none"> Multi-mode Power ON-delay Flicker x 2 Interval 	2 specifications 4 range settings Maximum range: · 0.1 s to 10 min · 0.1 min to 10 h	7 specifications · 100 to 120 VAC · 200 to 240 VAC · 100 to 110 VDC · 24 VAC · 12 VDC · 24 VDC · 48 VDC	3 specifications · DPDT relay · 4PDT relay · 4PDT relay with bifurcated contacts	PYF-08-PU-L PYF-14-PU-L

Choice No. 2

H3CR Series

The Plug-in Socket lets you replace the Timer without rewiring.

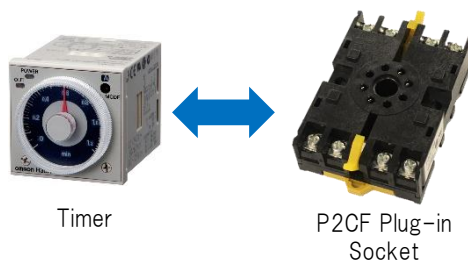

Choice No. 3

H3RN-B (H3RN) Series

The Plug-in Socket lets you replace the Timer without rewiring.

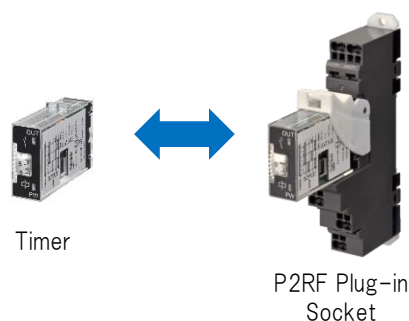

Model Selection Guide for Timers to fit your need

Installing Many Timers Together

Choice No. 1

H3Y-B/H3YN-B (H3Y/H3YN) Series

The Short Bar accessories are available to help reduce wiring work.

One-pole, Two-hole Push-In Plus Plug-in Socket to Enable Crossover Wiring

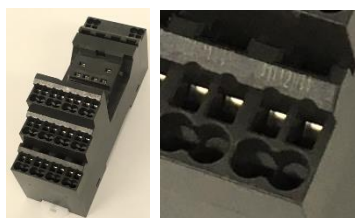

PYDN Short Bars

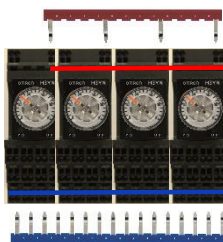

One-pole, Two-hole Construction for Crossover Wiring Even on Different Rows

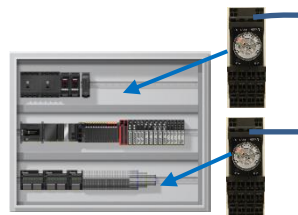

Model Overview

Series	Operating modes	Time ranges	Supply voltages	Output types	Recommended Sockets
H3Y-B	<ul style="list-style-type: none"> Power ON-delay 	13 range settings Maximum range: 0.04 s to 3 h	6 specifications · 100 to 120 VAC · 200 to 240 VAC · 100 to 110 VDC · 12 VDC · 24 VDC · 48 VDC	2 specifications · DPDT relay · 4PDT relay	PYF-08-PU-L PYF-14-PU-L
H3YN-B	<ul style="list-style-type: none"> Multi-mode Power ON-delay Flicker x 2 Interval 	2 specifications 4 range settings Maximum range: · 0.1 s to 10 min · 0.1 min to 10 h	7 specifications · 100 to 120 VAC · 200 to 240 VAC · 100 to 110 VDC · 24 VAC · 12 VDC · 24 VDC · 48 VDC	3 specifications · DPDT relay · 4PDT relay · 4PDT relay with bifurcated contacts	PYF-08-PU-L PYF-14-PU-L

Choice No. 2

H3RN-B (H3RN) Series

The Short Bar accessories are available to help reduce wiring work.



PYDN Short Bars

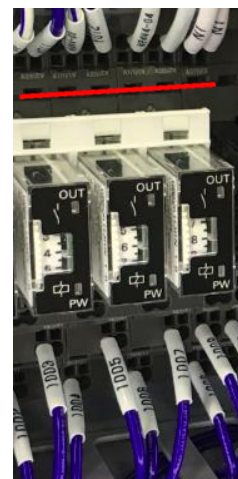

Model Selection Guide for Timers to fit your need

When Measurement Conditions Must Be Checked Frequently Onsite

Choice No. 1

H3CR Series

The large dial with a red color pointer and LEDs allows to check the operating status easily.

Flashes green during timing.

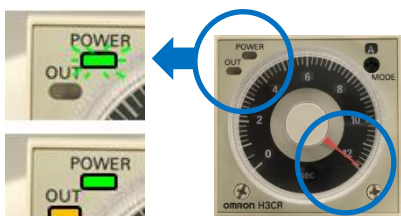

Lights orange during output.

Set value pointer

Model Overview

Series	Operating modes	Time ranges	Supply voltages	Output types	Recommended Sockets
H3CR-A	Multi-mode, 2 specifications · ON-delay · Flicker · Interval · Signal ON/OFF-delay · Signal OFF-delay · One shot	20 range settings 2 specifications Maximum range: · 0.05 s to 300 h · 0.1 s to 600 s	2 specifications · 100 to 240 VAC or 100 to 125 VDC · 24 to 48 VAC or 12 to 48 VDC	2 specifications · DPDT relay · One transistor output	P2CF-08 P2CF-11
H3CR-F	2 specifications (twin time setting) · Flicker OFF start · Flicker ON start	20 range settings Maximum range: 0.05 s to 300 h		DPDT relay	
H3CR-H	Power-OFF delay	4 range settings 2 specifications Maximum range: · 0.05 to 12 s · 0.05 to 12 min	5 specifications · 100/110/120 VAC · 200/220/240 VAC · 24 VAC/DC · 48 VDC · 100 to 125 VDC	2 specifications · DPDT relay · SPDT relay	P2CF-08 P2CF-11
H3CR-G	Star-delta timer	4 range settings Maximum range: 0.5 s to 120 s		2 specifications · SPST-NO relay (star operation circuit) · SPST-NO relay (delta operation circuit) · SPST-NO relay (star operation circuit) · SPST-NO relay (delta operation circuit) · SPST-NO relay (instantaneous output)	

Choice No. 2

H5CX Series

The set value and elapsed time are both displayed on a two-row display with changes between three colors for easy determination of operating status even from a distance.



Two-row Display
(Set Value and Elapsed Time)

Lit in Orange
During Output

Model Overview

Series	Operating modes	Time ranges	Supply voltages	Output types
H5CX-A with 4-digit display	Multi-mode · Signal ON-delay x 2 · Power ON-delay x 2 · Flicker x 2 · Signal OFF-delay · Interval · Cumulative · ON/OFF-duty-adjustable · Stopwatch	10 range settings Maximum range: 0.001 s to 9,999 h	2 specifications · 100 to 240 VAC · 24 VAC or 12 to 24 VDC	3 specifications · SPDT relay · DPDT relay · Transistor
H5CX-L with 4-digit display	· Twine timer flicker x 4 Multi-mode · Power ON-delay x 1 · Flicker x 1 · Interval · ON/OFF-duty-adjustable · Twine timer flicker x 2			
6-digit display	Multi-mode · Signal ON-delay · Cumulative	4 range settings Maximum range: 0.001 s to 9,999 h	24 VAC or 12 to 24 VDC	Transistors x 2

Model Selection Guide for Timers to fit your need

Avoiding Unapproved Changes to Settings

Choice No. 1

H3DS Series

A Lock Key can be used with a lock mechanism to prevent unintentional changes.



● Lock Key
(Order Separately)
Y92S-38



Model Overview

Series	Operating modes	Time ranges	Supply voltages	Output types
H3DS-ML	Multi-mode · ON-delay · Flicker · Interval · Signal ON/OFF-delay · Signal OFF-delay · One shot	7 range settings Maximum range: 0.1 s to 120 h	24 to 230 VAC or 24 to 48 VDC	SPDT relay
H3DS-SL	Multi-mode · ON-delay · Flicker · Interval · One shot			
H3DS-AL	Power ON-delay			

Lock

The time setting dial, time scale selector, and operating mode selector can be locked using the Y92S-38 Lock Key. The Lock Key is inserted in the keyhole and turned around to lock the dial or a selector.

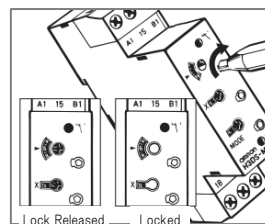

Choice No. 2

H5CX Series

There is a key-protect switch under the digital setting.



Lit while the key-protect switch is ON.

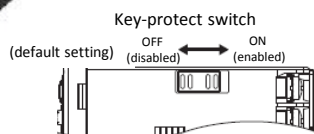

Model Overview

Series	Operating modes	Time ranges	Supply voltages	Output types
H5CX-A with 4-digit display	Multi-mode · Signal ON-delay x 2 · Power ON-delay x 2 · Flicker x 2 · Signal OFF-delay · Interval	10 range settings Maximum range: 0.001 s to 9,999 h	2 specifications · 100 to 240 VAC · 24 VAC or 12 to 24 VDC	3 specifications · SPDT relay · DPDT relay · Transistor
H5CX-L with 4-digit display	· Cumulative · ON/OFF-duty-adjustable · Stopwatch · Twine timer flicker x 4			
6-digit display	Multi-mode · Signal ON-delay · Cumulative	4 range settings Maximum range: 0.001 s to 9,999 h	24 VAC or 12 to 24 VDC	Transistors x 2

Model Selection Guide for Timers to fit your need

Mounting on a PCB

Choice No. 1

H3Y-B/H3YN-B (H3Y/H3YN) Series

Sockets and Hold-down Clips(sold separately) are available for soldering to PCBs.

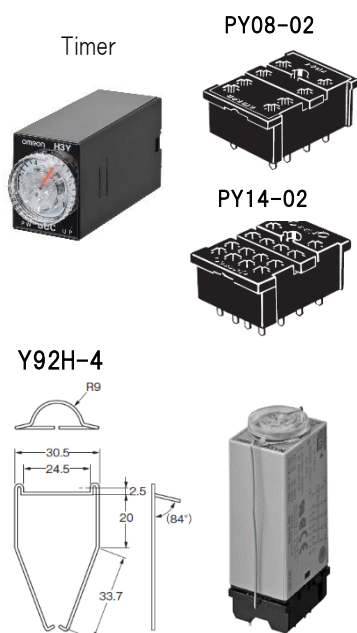

Model Overview

Series	Operating modes	Time ranges	Supply voltages	Output types	Recommended Sockets
H3Y-B	·Power ON-delay	13 range settings Maximum range: 0.04 s to 3 h	6 specifications ·100 to 120 VAC ·200 to 240 VAC ·100 to 110 VDC ·12 VDC ·24 VDC ·48 VDC	2 specifications ·DPDT relay ·4PDT relay	PYF-08-PU-L PYF-14-PU-L
H3YN-B	Multi-mode ·Power ON-delay ·Flicker x 2 ·Interval	2 specifications 4 range settings Maximum range: ·0.1 s to 10 min ·0.1 min to 10 h	7 specifications ·100 to 120 VAC ·200 to 240 VAC ·100 to 110 VDC ·24 VAC ·12 VDC ·24 VDC ·48 VDC	3 specifications ·DPDT relay ·4PDT relay ·4PDT relay with bifurcated contacts	PYF-08-PU-L PYF-14-PU-L

Choice No. 2

H3FA Series

These Timers are designed to be mounted on PCBs.



Model Overview

Series	Operating modes	Time ranges	Supply voltages	Output types
H3FA	Multi-mode ·Power ON-delay ·Cumulative	2 specifications 4 range settings Maximum range: ·0.1 s to 10 min ·0.6 s to 60 min	6 specifications ·5/6 VDC ·12/24 VDC ·5 VDC ·6 VDC ·12 VDC ·24 VDC	2 specifications ·SPST-NO, ·SPST-NC relay ·Transistor input

Model Selection Guide for Timers to fit your need

Designing for High Resistance to Vibration

Choice No. 1

H3Y-B/H3YN-B (H3Y/H3YN) Series

Hold-down Clips (sold separately) can be used to secure the Timers.
Using the Timers with Push-In Plus Sockets eliminates worrying about loose screws.

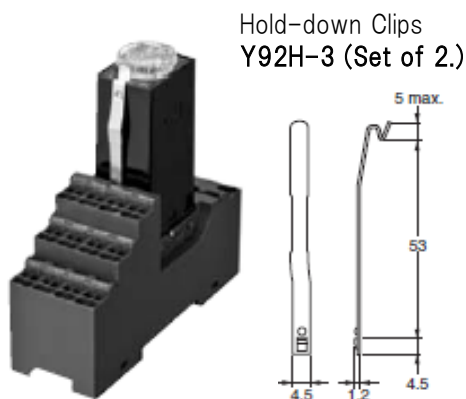

Model Overview

Series	Operating modes	Time ranges	Supply voltages	Output types	Recommended Sockets
H3Y-B	<ul style="list-style-type: none"> Power ON-delay 	<ul style="list-style-type: none"> 13 range settings Maximum range: 0.04 s to 3 h 	<ul style="list-style-type: none"> 6 specifications 100 to 120 VAC 200 to 240 VAC 100 to 110 VDC 12 VDC 24 VDC 48 VDC 	<ul style="list-style-type: none"> 2 specifications DPDT relay 4PDT relay 	<ul style="list-style-type: none"> PYF-08-PU-L PYF-14-PU-L
H3YN-B	<ul style="list-style-type: none"> Multi-mode Power ON-delay Flicker x 2 Interval 	<ul style="list-style-type: none"> 2 specifications 4 range settings Maximum range: 0.1 s to 10 min, 0.1 min to 10 h 	<ul style="list-style-type: none"> 7 specifications 100 to 120 VAC 200 to 240 VAC 100 to 110 VDC 24 VAC 12 VDC 24 VDC 48 VDC 	<ul style="list-style-type: none"> 3 specifications DPDT relay 4PDT relay 4PDT relay with bifurcated contacts 	<ul style="list-style-type: none"> PYF-08-PU-L PYF-14-PU-L

The PYF-□□-PU-L uses OMRON's Push-In Plus connection.

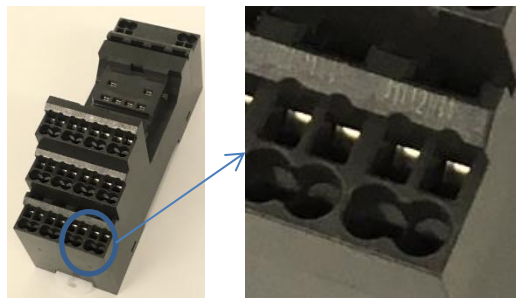

PYF-08-PU-L/PYF-14-PU-L

■ Retightening is not required for Push-In Plus Terminal Blocks.

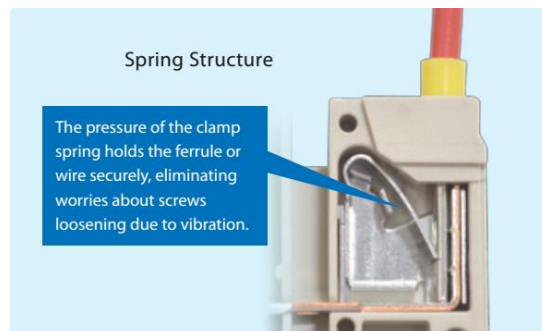

Model Selection Guide for Timers to fit your need

Using Star-delta Starting for a 3-phase Motor

Star-delta (Y- Δ) starting of 3-phase motors is the simplest starting method to restrict the inrush current to a motor. Star-delta Timers are designed for this application.

The power supply to the motor is connected to a trigger in a star connection for time t_1 and then connected to a delta connection after elapse of a further time t_2 . Both times are set on one Timer.

Example

Both outputs from the Timer are used as operation signals for electromagnetic contactors.

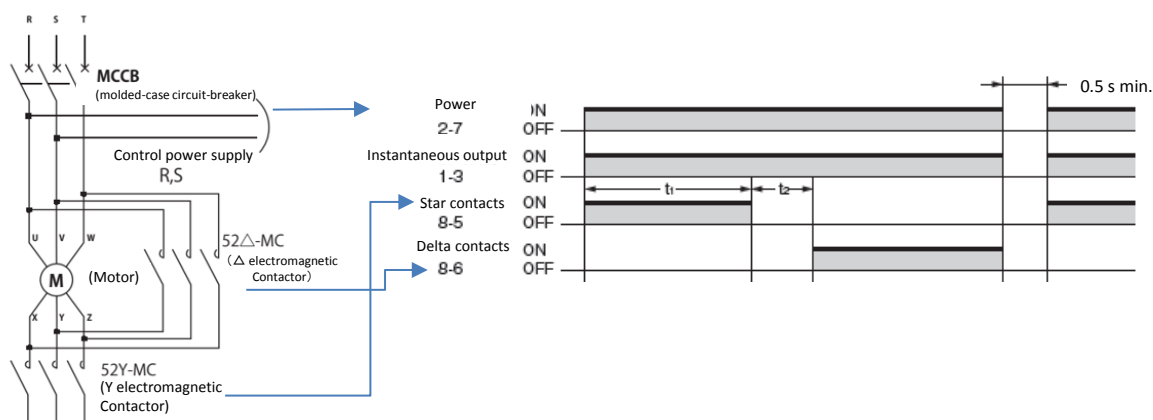

Example: H3CR-G Settings

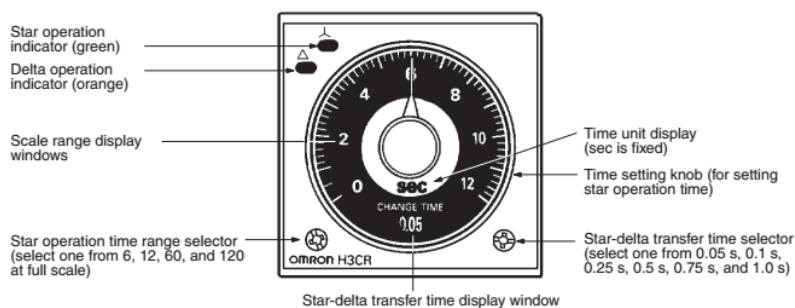



Model Overview

Choice No. 1

H3CR-G Series

Choice No. 2

H3DT-G Series

Series	Appearance	Time ranges	Supply voltages	Output types	Recommended Sockets
H3CR-G		4 range settings Maximum range: 0.5 s to 120 s	2 specifications ·100/110/120 VAC ·200/220/240 VAC	2 specifications ·SPST-NO relay (star operation circuit) SPST-NO relay (delta operation circuit) ·SPST-NO relay (star operation circuit) SPST-NO relay (delta operation circuit) SPST-NO relay (instantaneous output)	P2CF-08
H3DT-G		8 range settings Maximum range: 1 s to 120 s	24 to 240 VAC/DC	SPDT relay (star operation circuit) SPDT relay (delta operation circuit)	N/A

Model Selection Guide for Timers to fit your need

Setting ON and OFF Times Separately

A Twin Timer allows you to set different ON and OFF times for repetitive control operations instead of setting the same times for both.



The tON and tOFF times can be set separately.

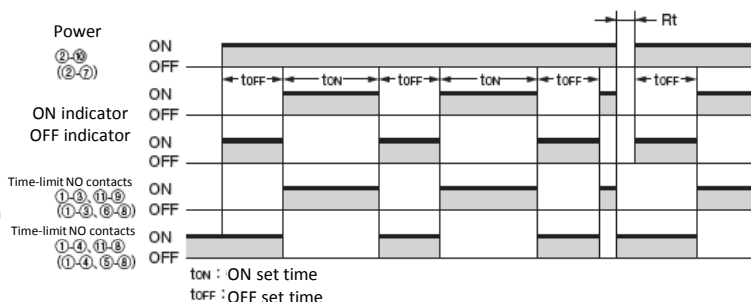

Example: A beeper repetitively turns ON for 1 second and OFF for 3 seconds while movable shelves are operating.

Example: H3CR-F Settings

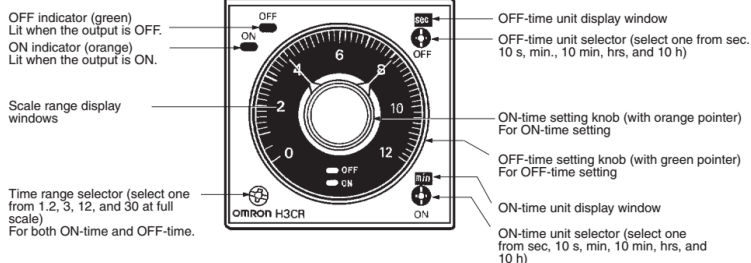

Choice No. 1

H3CR-F Series

Choice No. 2

H3DT-F Series

Choice No. 3

H5CX-A/L Series

Model Overview

Series	Appearance	Time ranges	Supply voltages	Output types	Recommended Sockets
H3CR-F		20 range settings Maximum range: 0.05 s to 300 h	2 specifications · 100 to 240 VAC or 100 to 125VDC · 24 to 48 VAC or 12 to 48 VDC	DPDT relay	P2CF-08 P2CF-11
H3DT-F		8 range settings Maximum range: 0.1 s to 1,200 h	24 to 240 VAC/DC	SPDT relay	N/A
H5CX-A H5CX-L		10 range settings Maximum range: 0.001 s to 9,999 h	2 specifications · 100 to 240 VAC · 24 VAC or 12 to 24 VDC	3 specifications · SPDT relay · DPDT relay · Transistor	N/A

Use the H3DT-F or H5CX when there is a large difference between the tON and tOFF times.

Model Selection Guide for Timers to fit your need

Using OFF-delay Operation for Power Interruptions

Normally, when the operating power for a Timer is lost, measuring time becomes impossible. However, with a Power OFF-delay Timer, power is stored in a capacitor in the Timer and timing is continued after power interruption until the Timer turns OFF after a specific period of time.

One example of application is in systems that switch to a backup power source when the power is interrupted. To prevent the backup mode from operating for momentary power interruptions, the power interruption time is measured and operation is switched to the backup power supply only when the power interruption continues for a specific period of time (e.g., 3 s).

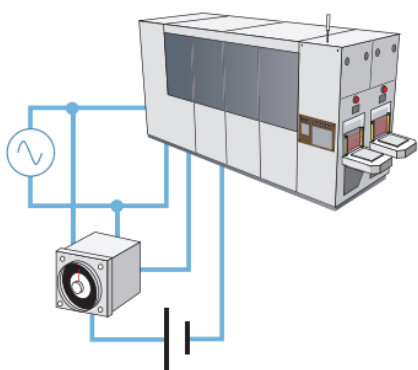

Example: Signal to Switch to Backup Power Source for Momentary Power Interruption

Timing Chart H3CR-H8L

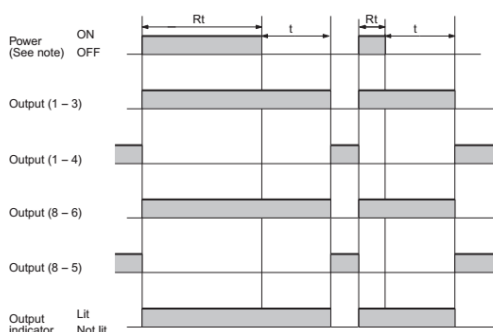

t: Set time

Rt: Minimum power ON time (S-series: 0.1 s min.; M-series: 2 s min.)

If the power ON time is less than this value, the Timer may not operate (i.e., output may not turn ON).

Example: H3CR-H Settings

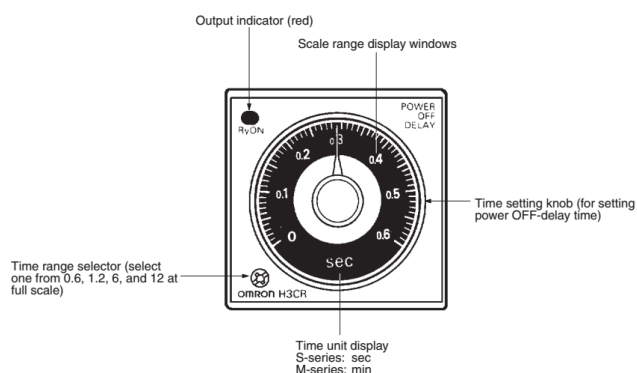



Choice No. 1

H3CR-H Series

Choice No. 2







H3DT-H Series

Model Overview

Series	Appearance	Time ranges	Supply voltages	Output types	Recommended Sockets
H3CR-H		4 range settings 2 specifications Maximum range: ·0.05 to 12 s ·0.05 to 12 min	5 specifications ·100/110/120 VAC ·200/220/240 VAC ·24 VAC/DC ·48 VDC ·100 to 125 VDC	2 specifications ·DPDT relay ·SPDT relay	P2CF-08 P2CF-11
H3DT-H		2 range settings 2 specifications Maximum range: ·0.1 to 12 s ·1 to 120 s	3 specifications ·100 to 120 VAC ·200 to 240 VAC ·24 to 48 VAC/DC	SPDT relay	N/A

Product List

Functions/Specifications

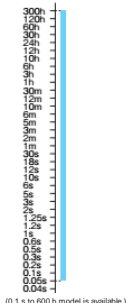
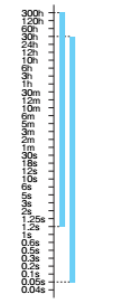
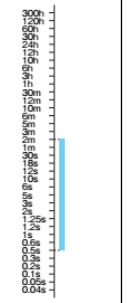
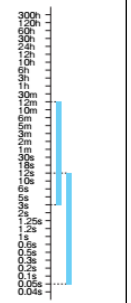
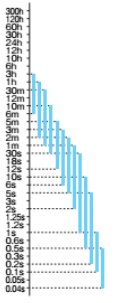
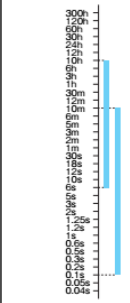
Category	Analog Timers					
	Multi-functional Timers	Twin Timers	Star-delta Time	Power OFF-delay Timers	ON-delay Timers	Multi-functional Timer
Operating modes	<ul style="list-style-type: none"> ·ON-delay ·Flicker ·Interval ·Signal ON/OFF-delay ·Signal OFF-delay ·One-shot output 	<ul style="list-style-type: none"> ·Flicker (independent ON-/OFF-time settings) 	<ul style="list-style-type: none"> ·Star-delta 	<ul style="list-style-type: none"> ·Power OFF-delay 	<ul style="list-style-type: none"> ·ON-delay 	<ul style="list-style-type: none"> ·ON-delay ·Interval ·Flicker
Model	H3CR-A	H3CR-F	H3CR-G	H3CR-H	H3Y/H3Y-□-B	H3YN/H3Y-N-□-B
Product name	Solid-state Timers					
Appearance and front-panel size (mm)	 DIN48 × 48	 DIN48 × 48	 DIN48 × 48	 DIN48 × 48	 21.5 × 28	 21.5 × 28
Features	<ul style="list-style-type: none"> ·Multiple time ranges and operating modes for DIN 48 x 48-mm ·Wide AC/DC power supply range for high or low voltages 	<ul style="list-style-type: none"> ·ON- and OFFtimes can be set independently ·Wide AC/DC power supply range for high or low voltages 	<ul style="list-style-type: none"> ·Set four time ranges between 0.5 and 120 s with one Timer 	<ul style="list-style-type: none"> ·Set four time ranges with each Timer, from 0.05 to 12 seconds for the S Series and from 0.05 to 12 minutes for the M Series 	<ul style="list-style-type: none"> ·Miniature ON-delay timers with Plug-in socket. 	<ul style="list-style-type: none"> ·Same shape as the H3Y with multiple time ranges and multiple operating modes
Surface	●	●	●	●	●	●
ON-panel (panel flushing)	●	●	●	●	●	●
DIN Track	●	●	●	●	●	●
PCB	—	—	—	—	● (H3Y)	—
Setting range	 (0.1 s to 600 h model is available.)					
Multiple time ranges	●	●	●	●	—	●
Terminal structure	Plug-in Pins (8 pins or 11 pins)	Plug-in Pins (8 pins or 11 pins)	Plug-in Pins (8 pins)	Plug-in Pin (8 pins or 11 pins)	H3Y-□-B Plug-in Pins for Push-In Plus Terminal Block socket H3Y Plug-in Pins for Screw Socket or PCB-mounting	H3Y-□-B Plug-in Pins for Push-In Plus Terminal Block socket H3YN Plug-in Pins for Screw Socket or PCB-mounting
Time-limit	● AC250V/DC30V 5A DC125V 0.15A	● AC250V/DC30V 5A	● AC250V/DC30V 5A	● AC250V/DC30V 5A	● 2-pole model: 5 A at 250 VAC, 4-pole model: 3 A at 250 VAC	● 2-pole model: 5 A at 250 VAC, 4-pole model: 3 A at 250 VAC
Time-limit and instantaneous	● AC250V 5A DC125V 0.15A	—	● AC250V/DC30V 5A	—	—	—
Transistor	● DC30V 100mA	—	—	—	—	—
Accuracy of operating time	±0.2% max.	±0.2% max.	±0.2% max.	±0.2% max.	±1% max.	1-s range: ±1% max. ±0.01 s max. Other ranges: ±1%
Setting error	±5% ±0.05s max.	±5% ±0.05s max.	±5% ±0.05s max.	±5% ±0.05s max.	±10% ±0.05s max.	±10% ±0.05s max.
Influence of voltage	±0.2% max.	±0.2% max.	±0.2% max.	±0.2% max.	±2% max.	±2% max.
Influence of temperature	±1% max.	±1% max.	±1% max.	±1% max.	±2% max.	±2% max.
Standards (See note 3.)	CE, UL, CSA, LR, CCC, NK	CE, UL, CSA, LR, CCC, NK	CE, UL, CSA, LR, CCC, NK	CE, UL, CSA, LR, CCC, NK	CE, UL, CSA, LR, CCC	CE, UL, CSA, LR, CCC







Note 1: The output capacity is when a resistive load is connected.

Note 2: Based on the full scale time, but for Digital timers, based on the set value.

Note 3: For the most recent information on models that have been certified for standards, refer to your OMRON website.

Product List

Functions/Specifications

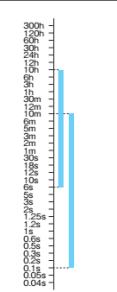
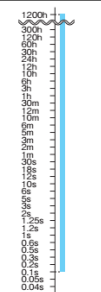
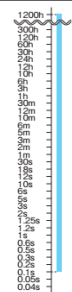
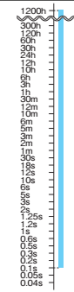
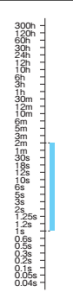
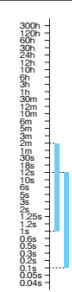
Category		Analog Timers						
		Multi-functional Timers	Multi-functional Timers	Power ON-delay	Twin Timers	Star-delta Timers	Power OFF-delay Timers	
Operating modes		<ul style="list-style-type: none"> · ON-delay · Interval · Flicker 	<ul style="list-style-type: none"> · ON-delay · Interval · Flicker · Signal ON/OFF-delay · Signal OFF-delay · One-shot output 	<ul style="list-style-type: none"> · Power ON-delay timer 	<ul style="list-style-type: none"> · Flicker (independent ON-/OFF-time settings) 	<ul style="list-style-type: none"> · Star-delta 	<ul style="list-style-type: none"> · Power OFF-delay 	
Model		H3RN/H3RN-□-B	H3DT-N/-L	H3DT-A	H3DT-F	H3DT-G	H3DT-H	
Product name		Solid-state Timers						
Appearance and front-panel size (mm)		 12.8 × 31.2	 17.5 × 90	 17.5 × 90	 17.5 × 90	 17.5 × 90	 17.5 × 90	
Features		<ul style="list-style-type: none"> · Multi-functional, compact, thin timers and the pin configuration are compatible with the G2R Relay 	<ul style="list-style-type: none"> · Push-In Plus Terminal Blocks · Multiple time ranges and operating modes let you cover a wide range of applications 	<ul style="list-style-type: none"> · Push-In Plus Terminal Blocks · Best for simple Power On-delay application 	<ul style="list-style-type: none"> · Push-In Plus Terminal Blocks · Switch between flicker-OFF or flicker-ON start mode · Independent ON time and OFF time settings 	<ul style="list-style-type: none"> · Push-In Plus Terminal Blocks · Set two time ranges with each Timer 	<ul style="list-style-type: none"> · Push-In Plus Terminal Blocks · Set two time ranges with each Timer, from 0.1 to 12 seconds for the S Series and from 1.0 to 120 seconds for the L Series 	
Surface		●	—	—	—	—	—	
ON-panel (panel flushing)		—	—	—	—	—	—	
DIN Track		●	●	●	●	●	●	
PCB		● (H3RN)	—	—	—	—	—	
Setting range								
Multiple time ranges		●	●	●	●	●	●	
Terminal structure		H3RN-□-B Plug-in Pins for Push-In Plus Terminal Block Socket H3RN Plug-in Pins for Screw Socket	Push-In Plus Terminal Block	Push-In Plus Terminal Block	Push-In Plus Terminal Block	Push-In Plus Terminal Block	Push-In Plus Terminal Block	
Time-limit	Relay	Output (See note 1.)	● AC250V 3A	● AC250V/DC30V 5A	● AC250V/DC30V 5A	● AC250V/DC30V 5A	● AC250V/DC30V 5A	● AC250V/DC30V 5A
Time-limit and instantaneous			—	● AC250V/DC30V 5A	—	—	—	—
Transistor			—	—	—	—	—	—
Accuracy of operating time	Time accuracy (See note 2.)	—	1-s range: ±1% max. ±0.01 s max. Other ranges: ±1%	±1% max.	±1% max.	±1% max.	±1% max.	±1% max.
Setting error			±15% ±0.05s max.	±10% ±0.05s max.	±10% ±0.05s max.	±10% ±0.05s max.	±10% ±0.05s max.	±10% ±0.05s max.
Influence of voltage			±2% max.	±0.5% max.	±0.5% max.	±0.5% max.	±0.5% max.	±0.5% max.
Influence of temperature	±2% max.	±2% max.	±2% max.	±2% max.	±2% max.	±2% max.		
Standards (See note 3.)		CE, UL, CSA	CE, UL, CSA, LR, CCC	CE, UL, CSA, LR, CCC	CE, UL, CSA, LR, CCC	CE, UL, CSA, LR, CCC	CE, UL, CSA, LR, CCC	





Note 1: The output capacity is when a resistive load is connected.

Note 2: Based on the full scale time, but for Digital timers, based on the set value.

Note 3: For the most recent information on models that have been certified for standards, refer to your OMRON website.

Product List

Functions/Specifications

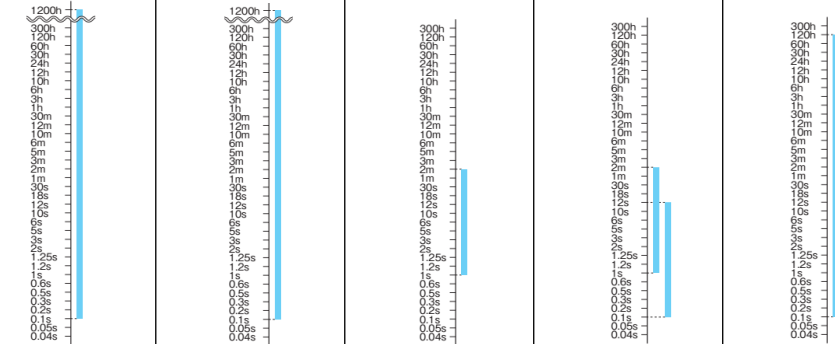
Category		Analog Timers				
		Multi-functional Timers	Twin Timers	Star-delta Time	Power OFF-delay Timers	Multi-functional Time
Operating modes		<ul style="list-style-type: none"> · ON-delay · Flicker · Interval · Signal ON/OFF-delay · Signal OFF-delay · One-shot output 	<ul style="list-style-type: none"> · Flicker (independent ON-/OFF-time settings) 	<ul style="list-style-type: none"> · Star-delta 	<ul style="list-style-type: none"> · Power OFF-delay 	<ul style="list-style-type: none"> · ON-delay · Flicker · Signal ON/OFF-delay · Signal OFF-delay · Interval · One-shot output
Model		H3DK-M/-S	H3DK-F	H3DK-G	H3DK-H	H3DS
Product name		Solid-state Timers				
Appearance and front-panel size (mm)		 22.5 × 79	 22.5 × 79	 22.5 × 79	 22.5 × 79	 17.5 × 80
Features		<ul style="list-style-type: none"> · Multiple time ranges and operating modes let you cover a wide range of applications 	<ul style="list-style-type: none"> · Switch between flicker-OFF or flicker-ON start mode · Independent ON time and OFF time settings 	<ul style="list-style-type: none"> · Set two time ranges between 1 and 120 s with one Timer 	<ul style="list-style-type: none"> · Set two time ranges with each Timer, from 0.1 to 12 seconds for the S Series and from 1.0 to 120 seconds for the L Series 	<ul style="list-style-type: none"> · DIN track-mounted, 17.5-mm-width standard timer series
Surface		—	—	—	—	—
ON-panel (panel flushing)		—	—	—	—	—
DIN Track		●	●	●	●	●
PCB		—	—	—	—	—
Setting range						
Multiple time ranges		●	●	●	●	●
Terminal structure		Screw Terminal block	Screw Terminal block	Screw Terminal block	Screw Terminal block	Screw Terminal block
Time-limit	Relay	●	●	●	●	●
Time-limit and instantaneous		●	—	—	—	—
Transistor		—	—	—	—	—
Accuracy of operating time	Time accuracy (See note 2.)	±1% max.	±1% max.	±1% max.	±1% max.	±1% max.
Setting error		±10% ±0.05s max.	±10% ±0.05s max.	±10% ±0.05s max.	±10% ±0.05s max.	±10% ±0.05s max.
Influence of voltage		±0.5% max.	±0.5% max.	±0.5% max.	±0.5% max.	±0.7% max.
Influence of temperature		±2% max.	±2% max.	±2% max.	±2% max.	±5% max.
Standards (See note 3.)		CE, UL, CCC, LR	CE, UL, CCC, LR	CE, UL, CCC, LR	CE, UL, CCC, LR	CE, UL, CSA, LR

Note 1: The output capacity is when a resistive load is connected.

Note 2: Based on the full scale time, but for Digital timers, based on the set value.

Note 3: For the most recent information on models that have been certified for standards, refer to your OMRON website.

Product List

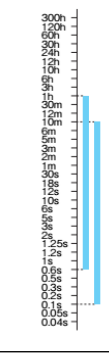

Functions/Specifications

Category		Analog Timers	
		Delay Relays	
Operating modes		<ul style="list-style-type: none"> · ON-delay · Cumulative · Signal OFF-delay · One-shot output 	
Model		H3FA	
Product name		Solid-state Timers	
Appearance and front-panel size (mm)		 36.9 × 17.5	
Features		<ul style="list-style-type: none"> · DIP model Timer for PC board use provides contact and solid-state output 	
Surface	Mounting	—	
ON-panel (panel flushing)		—	
DIN Track		—	
PCB		●	
Setting range			
Multiple time ranges		●	
Terminal structure		PCB-mounting	
Time-limit	Relay	Output (See note 1.)	● AC250V 3A
Time-limit and instantaneous			—
Transistor		● DC30V 150mA	
Accuracy of operating time	Time accuracy (See note 2.)	±0.5% max.	
Setting error		±0 to ±30%	
Influence of voltage		±1% max.	
Influence of temperature		±5% max.	
Standards (See note 3.)		UL, CSA	

Note 1: The output capacity is when a resistive load is connected.

Note 2: Based on the full scale time, but for Digital timers, based on the set value.

Note 3: For the most recent information on models that have been certified for standards, refer to your OMRON website.

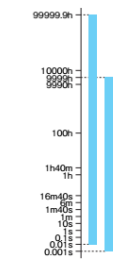
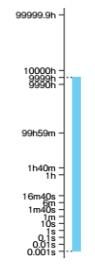
Category		Digital Timers	
		Operating modes	
Model		H5CX	H5CZ
Product name		Digital Timers	
Appearance and front-panel size (mm)		 DIN48 × 48	 DIN48 × 48
Features		<ul style="list-style-type: none"> · Short body with depth of only 59 mm and character height of 12 mm for better readability · Power supply circuit and input circuits are insulated · Easy-to-see, easy-to-use timers 	<ul style="list-style-type: none"> · General-purpose timers keeping the easy operation of the H5CX with good cost performance
Surface	Mounting	●	
ON-panel (panel flushing)		●	
DIN Track		●	
PCB		—	
Setting range			
Display	Character color	Red/Green/Orange (negative transmissive LCD: H5CX-A@-N only) or Red (negative transmissive LCD)	Monochrome LCD
	Number of digits	4 or 6 digits	4 digits
Setting switches		Digit Keys	Digit Keys
Terminal structure		Screw Terminal block or Plug-in Pins (8 pins or 11 pins)	Plug-in Pins (8 pins)
Time-limit	Relay	Output (See note 1.)	● AC250V/DC30V 5A
Time-limit and instantaneous			● AC250V/DC30V 5A
Transistor			● DC30V 100mA
Accuracy of operating time	Time accuracy (See note 2.)	±0.01% ±0.05 s max. for power-ON start	
Setting error		±0.005% ±0.03 s max. for signal start	
Influence of voltage		±0.005% ±3 ms max. for signal start with transistor output model	
Influence of temperature		—	
Waterproof on front panel		●	●
Standards		CE, UL, CCC	CE, UL, CCC

OMRON Corporation Industrial Automation Company
Kyoto, JAPAN

Contact: www.ia.omron.com

Regional Headquarters

OMRON EUROPE B.V.

Wegalaan 67-69, 2132 JD Hoofddorp
The Netherlands
Tel: (31)2356-81-300/Fax: (31)2356-81-388

OMRON ELECTRONICS LLC

2895 Greenspoint Parkway, Suite 200
Hoffman Estates, IL 60169 U.S.A.
Tel: (1) 847-843-7900/Fax: (1) 847-843-7787

OMRON ASIA PACIFIC PTE. LTD.

No. 438A Alexandra Road # 05-05/08 (Lobby 2),
Alexandra Technopark,
Singapore 119967
Tel: (65) 6835-3011/Fax: (65) 6835-2711

OMRON (CHINA) CO., LTD.

Room 2211, Bank of China Tower,
200 Yin Cheng Zhong Road,
PuDong New Area, Shanghai, 200120, China
Tel: (86) 21-5037-2222/Fax: (86) 21-5037-2200

Authorized Distributor:

© OMRON Corporation 2017 All Rights Reserved.
In the interest of product improvement,
specifications are subject to change without notice.

Cat. No. L130-E1-01

0617