

Omron's Ethernet Cables and Connectors

The best connection for both inside and outside the panel



In coordination with our extensive lineup of telecommunication products, our Ethernet cables deliver

Reliable connection quality

Industrial Ethernet Cables Series

With the growing prevalence of IoT, automated factory sites are also replacing serial connection with Ethernet as their main method of communication, and their expectations for connection quality are becoming increasingly demanding.

At Omron, we provide an extensive array of Industrial Ethernet cables and connectors that our unique technologies in connection (One-touch Smartclick) and environmental resistance to enable reliable connection. These products support both controller-level and device-level networks, and can be used together with general-purpose Ethernet as well.

You can ensure connection quality by coordinating them with our PLCs and other products from our assortment of Ethernet devices.



MACHINE CONTROL



FACTORY AUTOMATION

Machine Automation Controller / Industrial PC with Sysmac Machine Control



Filling line

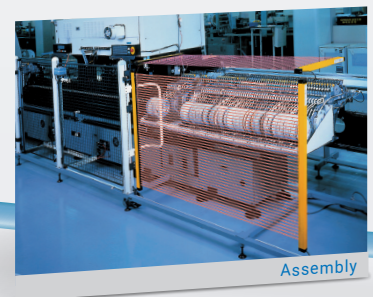

Assembly

 Motion

 Safety

INDEX

STEP1 | Select by standard / use environment STEP2 | Use properly products according to feature

- Select by cable standard (Ethernet speed) P.04
- Select by cable use environment P.05
- Product features P.06
- System configuration P.07

Information technologies

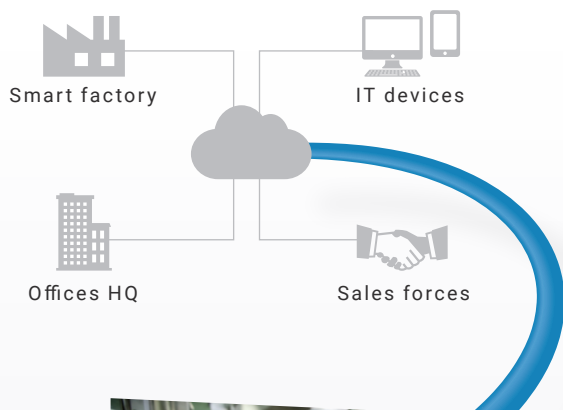

Information



Vision



Robot



Sensing

Main product lineup

For connecting Ethernet devices with EtherCAT / EtherNet/IP support

Cables with RJ45 Connectors XS6 Series*



*Some XS5W-T Series products also included.

Cables with M12 Connectors XS5□-T Series



Products for Fieldbus connection separately available

IO-Link support

DeviceNet support

Sensor I/O Connectors (M12/M8)

Peripherals for environment-resistant Remote I/O Terminals

XS5/2

XS3

DCN2

DCA1

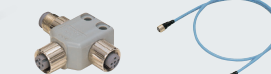

Cat.No.G106-E1

Cat.No.Q102-E1

Cat.No.X800-E1

Cat.No.G147-E1

STEP1 | Select by standard / use environment

Omron's Cables and Connectors support EtherNet/IP™, EtherCAT®, and other Industrial Ethernet, allowing for selection according to standard and use environment

1. Select by cable standard (Ethernet speed)

Be sure to use Ethernet Cables and Connectors that supports Ethernet speed you need. Check the Ethernet speed of your PLC, sensors, and any other component you plan to use and select cables and connectors that complies with the necessary standards.

		Cable and Connectors standards			
		Cat5	Cat5e	Cat6	Cat6A
Ethernet speed (Band rate)	10BASE-T	✓	✓	✓	✓
	100BASE-TX	✓	✓	✓	✓
	1000BASE-T	-	✓	✓	✓
	10GBASE-T	-	-	✓*	✓

✓...Supported
 *...Supported when cable length ≤37 m

Higher

Cat6A For high-speed communication

Cables with RJ45 Connectors

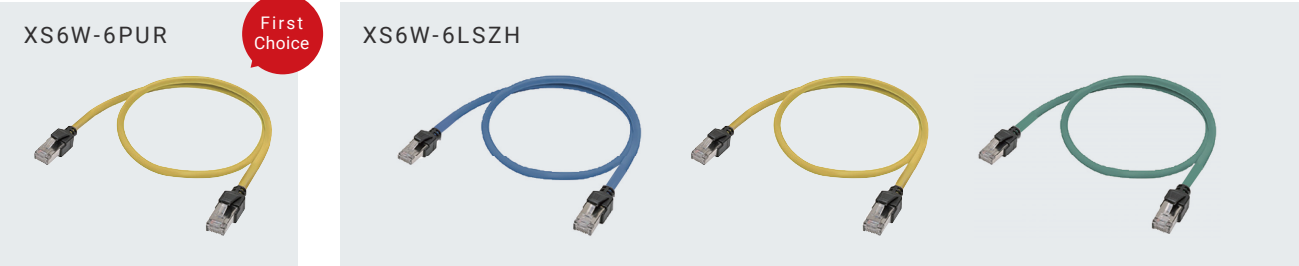

Cat5e

Cables with RJ45 Connectors



Cables with M12 Connectors (Round Water-resistant Connectors)



Notes: 1. We recommend for 100BASE-TX/10BASE-T, use STP (shielded twisted-pair) cable of category 5 or higher and 1000BASE-T, use STP cable of category 5e or higher with double shielding (aluminum tape and braiding).
 2. For Power over Ethernet (PoE) applications, use cable of category 5 or higher and make sure to check the rated values of both the PoE device and Ethernet Cables and Connectors.

2. Select by cable use environment

Use RJ45 connectors for in-panel wiring and M12 connectors (Round Water-resistant Connectors) with IP67 protection for wiring outside the control panel where environmental resistance is required.

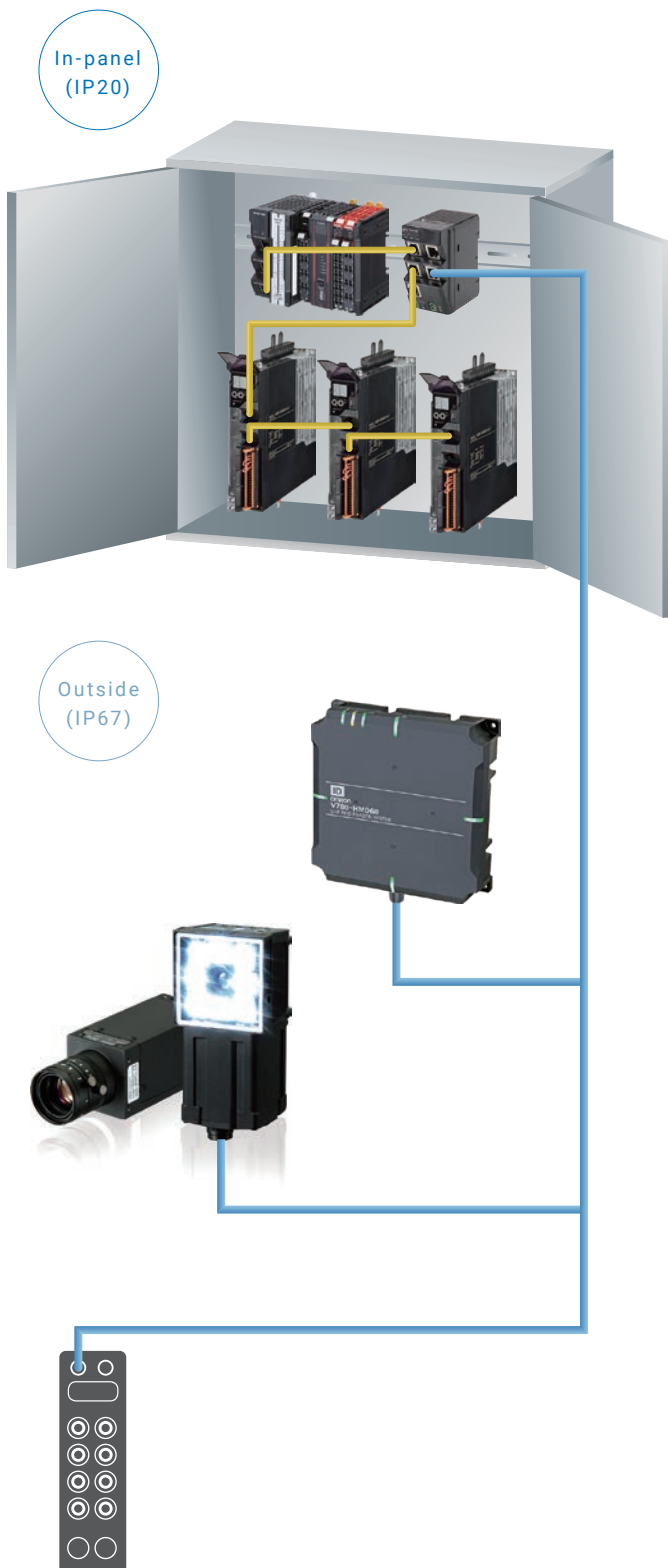

Cables with RJ45 connectors are ideal for in-panel wiring

XS6W



Cables with compact RJ45 connectors for in-panel use are available in two types: XS6W-6PUR with flexible cable, and XS6W-6LSZH with flame-retardant low smoke zero halogen cable.

Flexibility comparison data for cables with RJ45 connectors (XS6W-6LSZH/PUR)

Load required to bend the cable by 90°
 XS6W-6PUR: 16N
 XS6W-6LSZH: 25N

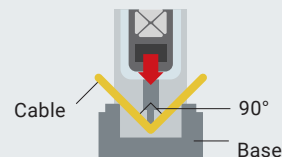

Models with tough latch for secure fastening also available
 XS5W-T421-□MD-□□

Cables with M12 connectors are ideal for wiring outside the control panel where environmental resistance is required

XS5□-T



Robot cables that can be used in moving application also available
 XS5W-T42□-□M□-□R

Cable bending test data for robot cables (XS5W-T421-□M□-□R)

Cableveyor test
 Number of bends:
 20 million min.

90° bending test
 Number of bends:
 6 million min.

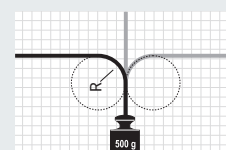

Speed: Approx.
 120 m/minute
 Distance moved: 1 m
 Cableveyor radius: 75 mm

Bending angle: ±90°
 Bending rate: Approx.
 30 times/minute
 Roll radius: 60 mm
 Load: 500 g

*Connected devices shown here are examples for illustration only.

Note: The data on this page are the results of OMRON testing. They may vary for your environment and application conditions. Treat them as a reference.

STEP2 | Use properly products according to feature

Extensive lineup of high-quality products allows for use of different models according to purpose

Product features

RJ45 Connectors

Cables with standard RJ45 Connectors XS6W-6PUR

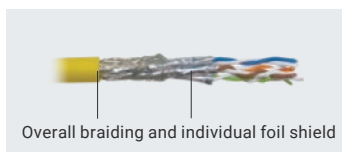

- Compact RJ45 connectors reduce in-panel cable routing space
- Enhanced wiring flexibility
- Double-shielded for use in hostile, noisy environments

>P.11

Cables with standard RJ45 Connectors XS6W-6LSZH

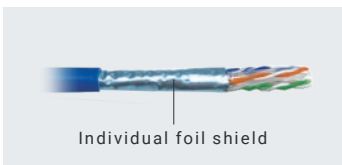

- Compact RJ45 connectors reduce in-panel cable routing space
- Flame-retardant low smoke zero halogen (LSZH) cables produce very little toxic gases even if they should burn
- Cable colors include blue, yellow, or green.

Note: This model, while single-shielded, has been confirmed to provide communication/noise characteristics that meet the standards.

>P.11

Cables with Rugged RJ45 Connectors XS5W-T421-□MD-□□

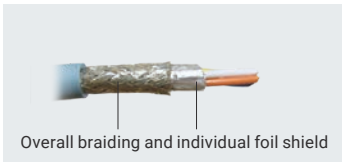

- RJ45 connectors with tough latch structure
- Double-shielded for use in hostile, noisy environments

>P.15

M12 Connectors

Cables with standard M12 Connectors XS5□-T42□-□M□-□□

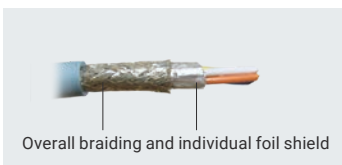

- Environment-resistant M12 connectors (Round Water-resistant Connectors) with IP67 protection that can be mated one-touch (approximately 1/8 of a turn)
- Double-shielded for use in hostile, noisy environments
- Extensive product lineup, including cables with right-angle connectors and those for panel mounting

>P.15

Cables with Strengthened shield M12 Connectors XS5□-T42□-□M□-SS

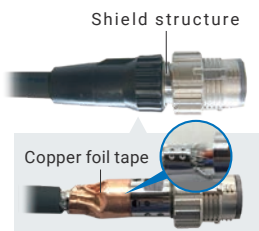

- Offers environmental resistance and one-touch mating, with strengthened shielding for enhanced noise resistance. Copper foil tape added to connector portion for improved communication characteristics.

>P.15

Note: Cables with RJ45/M12 Connectors also available. For more information, refer to list of product specifications, starting from page 10.

RJ45 Assembly Connectors XS6G-T421-1

Enables easy on-site Ethernet cable assembly without crimp tools or other special tools.

▶ Refer to page 24 for assembly instructions.

> P.15



System Configuration

Sysmac Automation Platform

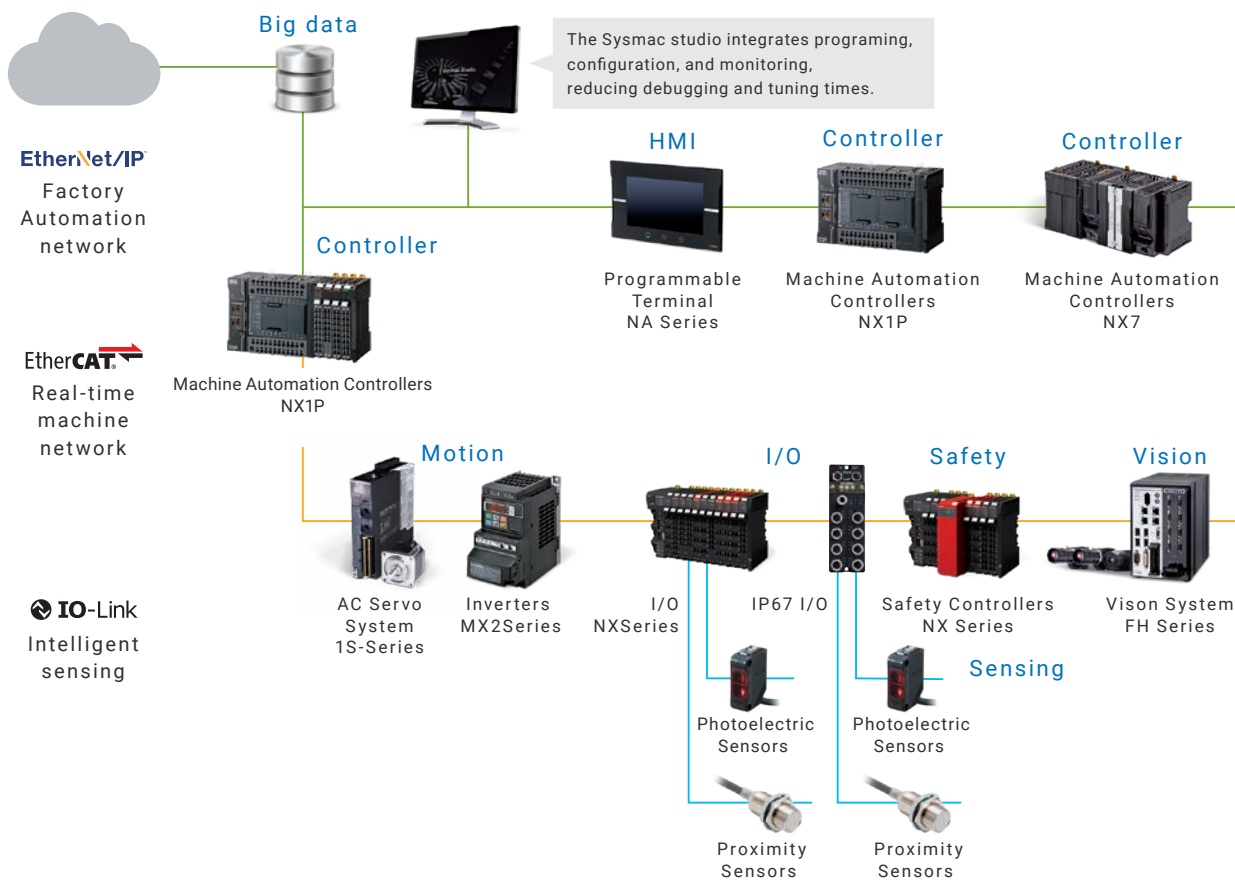

TIPS | Basic guide to Industrial Ethernet cables

Specifications of Industrial Ethernet cables

Twisted-pair cables and their shielding play key roles in ensuring communication quality in hostile factory.

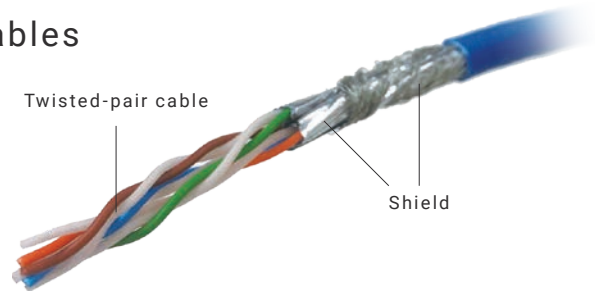

What is a twisted-pair cable?

A cable consisting of a pair of wires twisted together is commonly called a twisted-pair cable. Its relative resistance to noise has made it the cable most widely used for Ethernet and other communication.

Mechanism behind the twisted-pair cable's noise immunity

1. Field lines of the magnetic fields of electromagnetic waves cut across communication lines
2. Electric currents are induced
3. Noise interference acts in opposite directions, canceling each other out at each twist of the wires

Effects of shielding

Industrial twisted-pair cables are shielded to further improve their noise resistance. STP (shielded twisted-pair) cables, also called FTP (folded twisted-pair) cables, are distinguished from UTP (unshielded twisted-pair) cables used in regular office environments.

Internal cable structure

Note: Cables with two layers of shielding, as in the above photo, are said to be "double-shielded."

Shielding effects

The chart below demonstrates the shielding effects of unshielded, single-shielded, and double-shielded cables at 1 MHz. Higher numbers represent greater shielding effects (i.e. higher levels of noise interference reduction).

Comparison chart of shielded and unshielded cables

Cable Type	Shielding Effect (dB)
unshielded	0
Single-shielded	50
Double-shielded	60

Ethernet cable standards / points of note

There are several things to note in enabling stable operation of PLCs and other Ethernet communication devices. Observe the following when selecting and using Ethernet cables.

POINT1 Compliance to Ethernet cables standards

Ethernet is a LAN protocol, and based on standards by Ethernet speed (Band rate).

The higher the communication speed, the higher the transmission signal frequency and the more susceptible it is to noise. Choose the right cable to ensure standard-compliant communication speed.

- ▶ To find an Omron product that best suits your needs, see “1. Select by cable standard (band rate for Ethernet)” on page 04.

Standard requirement examples

10BASE-T	<ul style="list-style-type: none"> • 10 Mbit/s communication speed • Star network (LAN) with maximum cable length of 100 m
100BASE-TX	<ul style="list-style-type: none"> • High communication speed of 100 Mbit/s • Many 100BASE-TX devices are 10BASE-T compatible, allowing for mixed
10GBASE-T	<ul style="list-style-type: none"> • Next-generation high-speed network that can provide 10 Gbit/s connections • Significantly reduces data transfer time, increasing efficiency

POINT2 Ethernet cable wiring / use environment

Actual Ethernet cable wiring entails bending in many places, as shown in Figure 1.

When cables are bent (Figure 2), it induces noise; users should therefore take into account the place of installation (in-panel and outside), installation space, and equipment configuration and choose a cable that is suited for their purpose.

- ▶ To find an Omron product that best suits your needs, see “2. Select by cable use environment” on page 05.

Figure 1. Wiring example

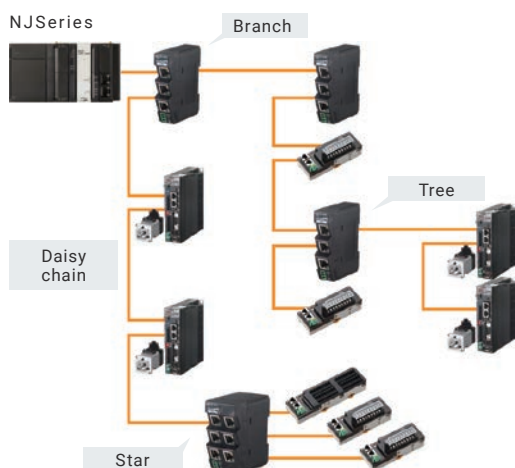
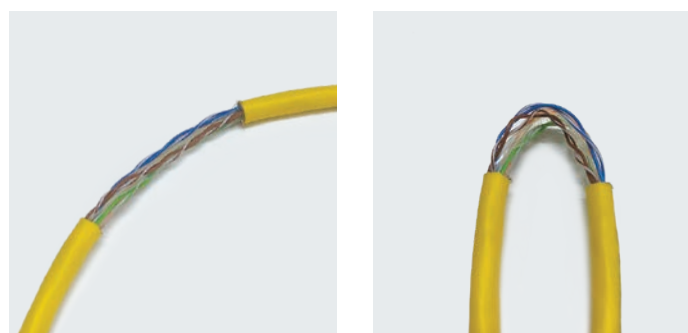

Figure 2. How bending can affect twisted-pair structure



Bending radius \geq specified minimum:
Twisted-pair structure intact

Bending radius $<$ specified minimum:
Twisted-pair structure iscompromised,
increasing noise susceptibility

Note: For minimum bending radius (R) values, see “Safety Precautions” on page 26.

Industrial Ethernet Cables XS5/XS6

Cables and Connectors for EtherNet/IP™, EtherCAT® and Other Industrial Ethernet Networks

Cables with RJ45 Connectors

- For in-panel wiring
- LSZH with Standard RJ45 Connectors (Cat6A)
- PUR with Standard RJ45 Connectors (Cat5 and Cat6A)
- PVC with Rugged RJ45 Connectors (Cat5e)

Cables with M12 Connectors (Round Water-resistant Connectors)

- For wiring outside the control panel where environmental resistance is required.
- PVC with M12 Connectors (Cat5e) that enables one-touch (1/8 turn) locking.
- XS5W-T42□-□-K/KR/SS* series products are UL certified.
- * Does not include all models.
- PVC Robot cable are available.



CE

Smartclick

For the most recent information on models that have been certified for safety standards, refer to your OMRON website.

Connection Examples

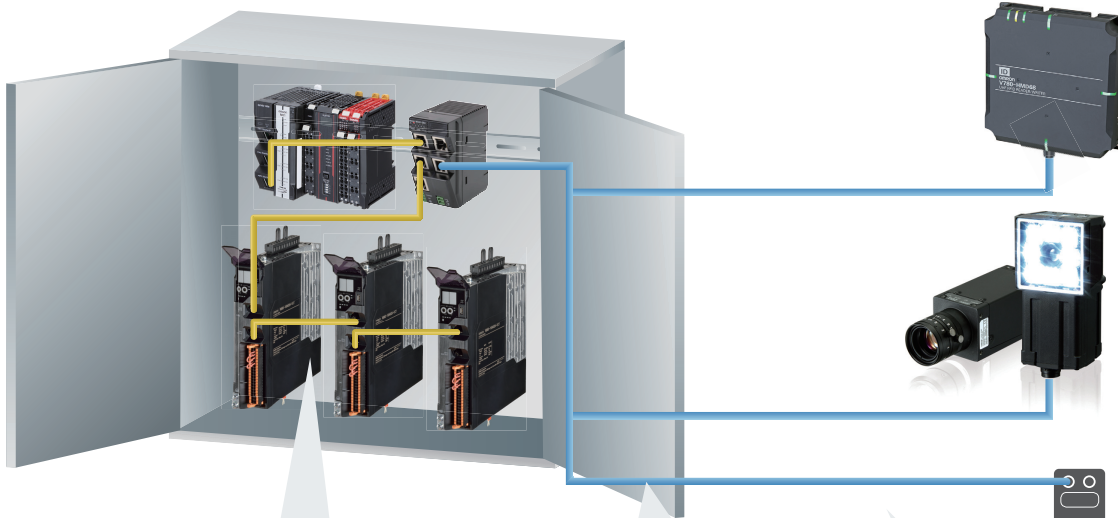

Ideal for in-panel wiring

Cables with RJ45 Connectors
XS6W-6LSZH



XS6W-6PUR

XS5W-T421-□MD-□□



Ideal for interface wiring the control panel

Cables with RJ45/M12 Connectors



XS5P-T (for panel mounting)



Ideal for wiring outside the control panel where environmental resistance is required

Cables with M12 Connectors
XS5□-T



Cables with Standard RJ45 Connectors

Model Number Structure

Model Number Legend

Use this legend when determining the product specifications from the model number. Choose from the model numbers listed in *Ordering Information* when ordering.

XS6W- **8 SS** CM-

① ② ③ ④ ⑤ ⑥ ⑦

① Transmission Characteristics

5: Category 5

6: Category 6A

② Sheath Material

LSZH: LSZH

PUR: PUR

③ Number of Pins

8: 8 pins

④ Cable Attachment Direction

SS: Straight/Straight

⑤ Cable Length

20: 0.2 m

30: 0.3 m

50: 0.5 m

100: 1 m

150: 1.5 m

200: 2 m

300: 3 m

500: 5 m

750: 7.5 m

1000: 10 m

1500: 15 m

2000: 20 m

⑥ Sheath Color

B: Blue

Y: Yellow

G: Green





⑦ Cable Specifications

F: Flexibility-improved Type (Standard Cable)

None: Standard Cagle

XS5/XS6

Ordering Information

Appearance	Cable specifications	Type	Category	Cable sheath material	Cable length (m)	Model
	Flexibility-improved Type (Standard Cable)			PUR	0.2	XS6W-6PUR8SS20CM-YF
					0.3	XS6W-6PUR8SS30CM-YF
					0.5	XS6W-6PUR8SS50CM-YF
					1	XS6W-6PUR8SS100CM-YF
					1.5	XS6W-6PUR8SS150CM-YF
					2	XS6W-6PUR8SS200CM-YF
					3	XS6W-6PUR8SS300CM-YF
					5	XS6W-6PUR8SS500CM-YF
					7.5	XS6W-6PUR8SS750CM-YF
					10	XS6W-6PUR8SS1000CM-YF
			Cat6A		0.2	XS6W-6LSZH8SS20CM-B
					0.3	XS6W-6LSZH8SS30CM-B
					0.5	XS6W-6LSZH8SS50CM-B
					1	XS6W-6LSZH8SS100CM-B
					1.5	XS6W-6LSZH8SS150CM-B
					2	XS6W-6LSZH8SS200CM-B
					3	XS6W-6LSZH8SS300CM-B
					5	XS6W-6LSZH8SS500CM-B
					7.5	XS6W-6LSZH8SS750CM-B
					10	XS6W-6LSZH8SS1000CM-B
	Standard Cable	Cable with Connectors on Both Ends (RJ45/RJ45)	Cat6A		0.2	XS6W-6LSZH8SS20CM-Y
					0.3	XS6W-6LSZH8SS30CM-Y
					0.5	XS6W-6LSZH8SS50CM-Y
					1	XS6W-6LSZH8SS100CM-Y
					1.5	XS6W-6LSZH8SS150CM-Y
					2	XS6W-6LSZH8SS200CM-Y
					3	XS6W-6LSZH8SS300CM-Y
					5	XS6W-6LSZH8SS500CM-Y
					7.5	XS6W-6LSZH8SS750CM-Y
					10	XS6W-6LSZH8SS1000CM-Y
			Cat6A		0.2	XS6W-6LSZH8SS20CM-G
					0.3	XS6W-6LSZH8SS30CM-G
					0.5	XS6W-6LSZH8SS50CM-G
					1	XS6W-6LSZH8SS100CM-G
					1.5	XS6W-6LSZH8SS150CM-G
					2	XS6W-6LSZH8SS200CM-G
					3	XS6W-6LSZH8SS300CM-G
					5	XS6W-6LSZH8SS500CM-G
					7.5	XS6W-6LSZH8SS750CM-G
					10	XS6W-6LSZH8SS1000CM-G
			Cat5	PUR	0.5	XS6W-5PUR8SS50CM-G
					1	XS6W-5PUR8SS100CM-G
					1.5	XS6W-5PUR8SS150CM-G
					2	XS6W-5PUR8SS200CM-G
					3	XS6W-5PUR8SS300CM-G
					5	XS6W-5PUR8SS500CM-G
					7.5	XS6W-5PUR8SS750CM-G
					10	XS6W-5PUR8SS1000CM-G
					15	XS6W-5PUR8SS1500CM-G
					20	XS6W-5PUR8SS2000CM-G

Specifications

Item	Type	Cable with Connectors on Both Ends (RJ45/RJ45)/LSZH		Cable with Connectors on Both Ends (RJ45/RJ45)/PUR	
	Model	XS6W-6LSZH8SS□□□□CM-□	XS6W-5PUR8SS□□□□CM-G	XS6W-6PUR8SS□□□□CM-YF	
Rated current	1 A (at 50°C)				
Rated voltage *	30 VDC				
Contact resistance	20 mΩ max.				
Insulation resistance	500 MΩ min.				
Withstand voltage	1,000 VDC for 60 s (leakage current: 1 mA max.)				
Ambient operating temperature	-20 to 75°C	-40 to 80°C	-30 to 75°C		
Ambient storage temperature	-20 to 75°C	-40 to 80°C	-20 to 70°C		
Protective structure	IP20				

* Voltage varies by installation environment.

Materials and Finish

● Connectors

Item	Type	Cable with Connectors on Both Ends (RJ45/RJ45)/LSZH		Cable with Connectors on Both Ends (RJ45/RJ45)/PUR	
	Model	XS6W-6LSZH8SS□□□□CM-□	XS6W-5PUR8SS□□□□CM-G	XS6W-6PUR8SS□□□□CM-YF	
Connector housing	PC resin				
Contacts	Copper alloy/Gold plating				
Shield	Copper alloy/Nickel plating				
Anchors	---				
Anchors (tabs)	---				
Cover (structured to prevent the tab from breaking)	PA resin				
Marking tube	PVC resin			---	

● Cables

Item	Type	Cable with Connectors on Both Ends (RJ45/RJ45)/LSZH		Cable with Connectors on Both Ends (RJ45/RJ45)/PUR	
	Model	XS6W-6LSZH8SS□□□□CM-□	XS6W-5PUR8SS□□□□CM-G	XS6W-6PUR8SS□□□□CM-YF	
Compliant standard	IEC 60332-1 /UL444		IEC 60332-1	IEC 61156-6, IEC11801, IEC 60332-1	
Category	Cat6A		Cat5	Cat6A	
Number of cores	AWG26				
Outer diameter *1	6.3 dia.		6.0 dia.	6.5 dia.	
Sheath color *2	Blue, Yellow, Green		Green	Yellow	
Sheath material	LSZH		PUR		
Shield structure	Single shield		Double shield		

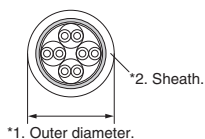

XS5/XS6

Dimensions

(Unit: mm)

- Cable with Connectors on Both Ends (RJ45/RJ45)
- Flexibility-improved Type (Standard Cable)
- XS6W-6PUR8SS□□□□CM-YF

Wiring

RJ45	RJ45
1	1
2	2
3	3
4	4
5	5
6	6
7	7
8	8
Shield	Shield



Color ●

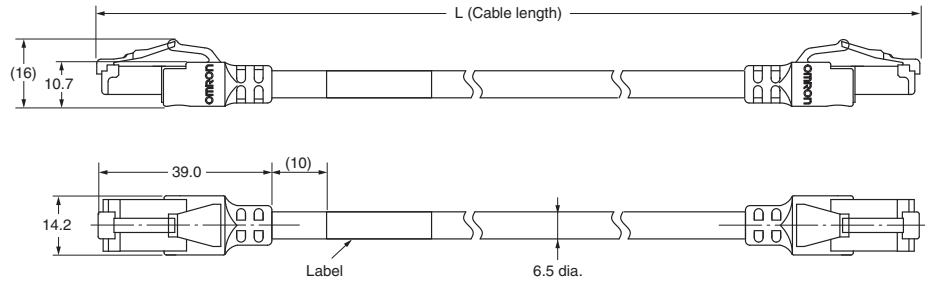

- Cable with Connectors on Both Ends (RJ45/RJ45)
- XS6W-6LSZH8SS□□□□CM-□
- XS6W-5PUR8SS□□□□CM-G

Wiring

RJ45	RJ45
1	1
2	2
3	3
4	4
5	5
6	6
7	7
8	8
Shield	Shield



Color ●●●

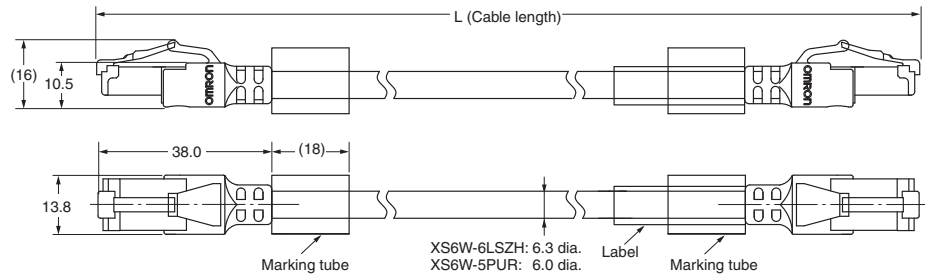

Cables with Rugged RJ45 Connectors, and Cables with M12 Connectors (Round Water-resistant Connectors)

Model Number Structure

Model Number Legend

Use this legend when determining the product specifications from the model number. Choose from the model numbers listed in *Ordering Information* when ordering.

● Cable with Connectors

XS5 □-T 4 2 □-□M□-□□

① ② ③ ④ ⑤ ⑥ ⑦ ⑧

① Connector Shape

H: Cable with plug on one end

W: Cable with connectors on both ends

② Type

T: Ethernet

③ Number of Pins

4: 4 pins

④ Contact Plating Specification

2: Gold plating

⑤ Cable Attachment Direction (M12 Connectors)

1: Straight

2: Right angle

⑥ Cable Length

A: 0.3 m	J: 10 m
B: 0.5 m	K: 15 m
C: 1 m	L: 20 m
D: 2 m	T: 25 m
E: 3 m	N: 30 m
F: 4 m	Z: 35 m
W: 4.5 m	P: 40 m
G: 5 m	X: 50 m

⑦ Connector Shape

0: M12 plug on one end

1: Connectors on both ends: M12 socket/M12 plug

2: Connectors on both ends: M12 plug/M12 plug

3: Connections on both ends: M12 socket/M12 socket

C: Connectors on both ends: M12 plug/RJ45 plug

D: Connectors on both ends: RJ45 plug/RJ45 plug

E: Connectors on both ends: M12 socket/RJ45 plug

⑧ Cable Specification

K: Standard cable (Cable color: Light blue)

Y: Standard cable (Cable color: Yellow)

KR: Robot cable (Cable color: Light blue)

YR: Robot cable (Cable color: Yellow)

SS: Shield Strengthening model

(Standard cable, Cable color: Black)

Note. M12 connector locking type is D-coding.

● RJ45 Assembly Connectors

XS6G-T 4 2 1-1

① ② ③ ④ ⑤

① Type

T: Ethernet

② Number of Pins

4: 4 pins

③ Contact Plating Specification

2: Gold plating

④ Cable Attachment Direction

1: Straight

⑤ Degree of Protection

1: IP20

● M12 Connectors for Panel Mounting

XS5P-T 4 2 □-□

① ② ③ ④ ⑤

① Type

T: Ethernet

② Number of Pins

4: 4 pins

③ Plating Specification

2: Gold plating

④ Mounting Method

6: Rear locking

7: Front locking

8: Rear locking (with connector anti-rotation mechanism)

⑤ Terminal Shape







1: DIP terminalst

5: Cable with loose wires (0.5 m)



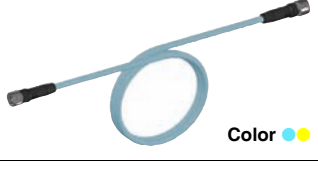
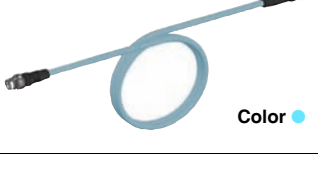

XS5/XS6

Ordering Information

Appearance	Cable specifications	Category	Cable sheath material	Type	Cable length (m)	Model
<p>Color ●</p>	Standard Cable	Cat5e	PVC	Cable with Plug on One End (M12 Straight)	0.5	XS5H-T421-BM0-K
					1	XS5H-T421-CM0-K
					2	XS5H-T421-DM0-K
					3	XS5H-T421-EM0-K
					5	XS5H-T421-GM0-K
					10	XS5H-T421-JM0-K
					15	XS5H-T421-KM0-K
<p>Color ●●</p>				Cable with Plugs on Both Ends (M12 Straight/M12 Straight)	0.5	XS5W-T421-BM2-K
					1	XS5W-T421-CM2-K
					2	XS5W-T421-DM2-K
					3	XS5W-T421-EM2-K
					5	XS5W-T421-GM2-K
					10	XS5W-T421-JM2-K
					15	XS5W-T421-KM2-K
					0.3	XS5W-T421-AM2-Y
					0.5	XS5W-T421-BM2-Y
					1	XS5W-T421-CM2-Y
					2	XS5W-T421-DM2-Y
					3	XS5W-T421-EM2-Y
					5	XS5W-T421-GM2-Y
					<p>Color ●●</p>	Cable with Plugs on Both Ends (M12 Straight/RJ45)
0.5				XS5W-T421-BMC-K		
1				XS5W-T421-CMC-K		
2				XS5W-T421-DMC-K		
3				XS5W-T421-EMC-K		
5				XS5W-T421-GMC-K		
10				XS5W-T421-JMC-K		
15				XS5W-T421-KMC-K		
0.3	XS5W-T421-AMC-Y					
0.5	XS5W-T421-BMC-Y					
1	XS5W-T421-CMC-Y					
2	XS5W-T421-DMC-Y					
3	XS5W-T421-EMC-Y					
5	XS5W-T421-GMC-Y					
<p>Color ●</p>	Cable with Plug on One End (M12 Right-angle)	0.3	XS5H-T422-AM0-K			
		0.5	XS5H-T422-BM0-K			
		1	XS5H-T422-CM0-K			
		2	XS5H-T422-DM0-K			
		3	XS5H-T422-EM0-K			
		5	XS5H-T422-GM0-K			
		10	XS5H-T422-JM0-K			
15	XS5H-T422-KM0-K					
<p>Color ●</p>	Cable with Plugs on Both Ends (M12 Right-angle/M12 Right-angle)	0.3	XS5W-T422-AM2-K			
		0.5	XS5H-T422-BM2-K			
		1	XS5W-T422-CM2-K			
		2	XS5W-T422-DM2-K			
		3	XS5W-T422-EM2-K			
		5	XS5W-T422-GM2-K			
10	XS5W-T422-JM2-K					
15	XS5W-T422-KM2-K					
<p>Color ●</p>	Cable with Plugs on Both Ends (M12 Right-angle/RJ45)	0.3	XS5W-T422-AMC-K			
		0.5	XS5W-T422-BMC-K			
		1	XS5W-T422-CMC-K			
		2	XS5W-T422-DMC-K			
		3	XS5W-T422-EMC-K			
		5	XS5W-T422-GMC-K			
10	XS5W-T422-JMC-K					
15	XS5W-T422-KMC-K					
<p>Color ●</p>	Cable with Plugs on Both Ends (RJ45/RJ45)	0.3	XS5W-T421-AMD-K			
		0.5	XS5W-T421-BMD-K			
		1	XS5W-T421-CMD-K			
		2	XS5W-T421-DMD-K			
		3	XS5W-T421-EMD-K			
		5	XS5W-T421-GMD-K			
10	XS5W-T421-JMD-K					
15	XS5W-T421-KMD-K					

Appearance	Cable specifications	Category	Cable sheath material	Type	Cable length (m)	Model
 <p>Color ●</p>	Standard Cable	Cat5e	PVC	Cable with Plug on One End and Socket on Other End (M12 Straight/M12 Straight)	0.5	XS5W-T421-BM1-K
					1	XS5W-T421-CM1-K
					2	XS5W-T421-DM1-K
					3	XS5W-T421-EM1-K
					5	XS5W-T421-GM1-K
					10	XS5W-T421-JM1-K
 <p>Color ●</p>	Standard Cable	Cat5e	PVC	Cable with Plug on One End and Socket on Other End (M12 Straight/RJ45)	0.5	XS5W-T421-BME-K
					1	XS5W-T421-CME-K
					2	XS5W-T421-DME-K
					3	XS5W-T421-EME-K
					5	XS5W-T421-GME-K
					10	XS5W-T421-JME-K
 <p>Color ●●</p>	Standard Cable	Cat5e	PVC	Cable with Socket on Both Ends (M12 Straight/M12 Straight)	1	XS5W-T421-CM3-K
					2	XS5W-T421-DM3-K
 <p>Color ●●</p>	Standard Cable	Cat5e	PVC	Cable with Plug on One End and Socket on Other End (M12 Straight/M12 Straight)	0.5	XS5W-T421-BM1-KR
					1	XS5W-T421-CM1-KR
					2	XS5W-T421-DM1-KR
					3	XS5W-T421-EM1-KR
					5	XS5W-T421-GM1-KR
					10	XS5W-T421-JM1-KR
 <p>Color ●●</p>	Standard Cable	Cat5e	PVC	Cable with Plugs on Both Ends (M12 Straight/M12 Straight)	0.5	XS5W-T421-BM2-KR
					1	XS5W-T421-CM2-KR
					2	XS5W-T421-DM2-KR
					3	XS5W-T421-EM2-KR
					5	XS5W-T421-GM2-KR
					10	XS5W-T421-JM2-KR
					15	XS5W-T421-KM2-KR
					1	XS5W-T421-CM2-YR
					2	XS5W-T421-DM2-YR
					3	XS5W-T421-EM2-YR
					5	XS5W-T421-GM2-YR
					 <p>Color ●●</p>	Robot Cable
1	XS5W-T421-CMC-KR					
2	XS5W-T421-DMC-KR					
3	XS5W-T421-EMC-KR					
5	XS5W-T421-GMC-KR					
10	XS5W-T421-JMC-KR					
15	XS5W-T421-KMC-KR					
3	XS5W-T421-EMC-YR					
5	XS5W-T421-GMC-YR					
10	XS5W-T421-JMC-YR					
15	XS5W-T421-KMC-YR					
20	XS5W-T421-LMC-YR					
 <p>Color ●●</p>	Robot Cable	Cat5e	PVC	Cable with Plugs on Both Ends (RJ45/RJ45)	0.5	XS5W-T421-BMD-KR
					1	XS5W-T421-CMD-KR
					2	XS5W-T421-DMD-KR
					3	XS5W-T421-EMD-KR
					5	XS5W-T421-GMD-KR
					10	XS5W-T421-JMD-KR
					15	XS5W-T421-KMD-KR
					0.5	XS5W-T421-BMD-YR
					1	XS5W-T421-CMD-YR
					2	XS5W-T421-DMD-YR
					3	XS5W-T421-EMD-YR
					5	XS5W-T421-GMD-YR

Note.For cable lengths other than those listed above, refer to page 25.

Appearance	Cable specifications	Category	Cable sheath material	Type	Cable length (m)	Model				
 <p>Color ●</p>	Shield Strengthening model (Standard cable)	Cat5e	PVC	Cable with Plugs on Both Ends (M12 Straight/M12 Straight)	0.5	XS5W-T421-BM2-SS				
					1	XS5W-T421-CM2-SS				
					2	XS5W-T421-DM2-SS				
					3	XS5W-T421-EM2-SS				
					5	XS5W-T421-GM2-SS				
				 <p>Color ●</p>	---	Cat5e	---	Cable with Plugs on Both Ends (M12 Straight/RJ45)	0.5	XS5W-T421-BMC-SS
									1	XS5W-T421-CMC-SS
									2	XS5W-T421-DMC-SS
									3	XS5W-T421-EMC-SS
									5	XS5W-T421-GMC-SS
	---	Cat5	---	RJ45 Assembly Connector	---	XS6G-T421-1				
						Cat5e	---	M12 Connector for Panel Mounting *	Rear locking	0.5
Rear locking (with connector anti-rotation mechanism)	0.5	XS5P-T428-5								
Front locking	0.5	XS5P-T427-5								
	---	---	---	M12 Panel-mounting PCB Straight Terminals *	---	XS5P-T426-1				

Note. Please consult with OMRON for types other than the above.

* The rear locking type is attached from the front of the panel, and the nut is tightened from the back.

The front locking type is attached from the back of the panel, and the nut is tightened from the front.

● Cable Bending Data for Robot Cables (XS5W-T421-□M□-□R)

The following data is the results of OMRON testing for cable bending test conditions. The number of bends may vary for your environment and application conditions.

Cableveyor test

Number of bends: 20 million min.



Speed: Approx. 120 m/minute

Distance moved: 1 m

Cableveyor radius: 75 mm

90° bending test

Number of bends: 6 million min.

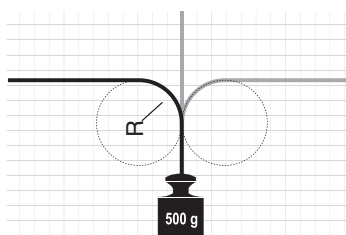

Bending angle: ±90°

Bending rate: Approx. 30 times/minute

Roll radius: 60 mm

Load: 500 g

● IEC 61076-2-101 Compliant M12 Connector Pinout Diagram (from Mating Side)

Coding refers to the shape of the connector mating part, which prevents incorrect mating.

The mating shape of M12 connectors for Ethernet is D-coding.

D-coding

Plug

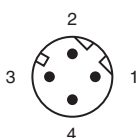

Socket

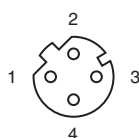

Specifications

Item	Type	M12	RJ45 (including RJ45/M12 Connector cable type)	M12 Connectors for Panel Mounting
	Model	XS5H-T42□-□M0-K XS5W-T42□-□M1-□□ XS5W-T42□-□M2-□□ XS5W-T42□-□M3-□□	XS5W-T42□-□MC-□□ XS5W-T42□-□MD-□□ XS5W-T42□-□ME-□□ XS6G-T421-1	XS5P-T42□-5 XS5P-T426-1
Rated current		3 A	2.5 A	4 A
Rated voltage *1		30 VDC		125 VDC
Contact resistance		40 mΩ max.		
Insulation resistance		1,000 MΩ min.	500 MΩ min.	1,000 MΩ min.
Withstand voltage		1,000 VAC for 60 s (leakage current: 1 mA max.)		1,500 VAC for 60 s (leakage current: 1 mA max.)
Ambient operating temperature		-25 to 70°C *2		
Ambient storage temperature		-25 to 70°C		
Protective structure		M12: IEC IP67, RJ45: IEC IP20		

*1. Voltage varies by installation environment.

*2. Use robot cable within a temperature range of 0 to 70°C to avoid wire breakage when moving.

Materials and Finish

● Connectors

Item	Type	M12		RJ45
	Model	XS5H/W-T	XS5P-T42□-5	XS5P-T426-1 XS5W-T and XS6G
Contact blocks		PBT resin		PA resin
Contacts		Copper alloy/Gold plating		
Anchors		Zinc alloy/Nickel plating		---
Anchors (tabs)		Stainless	---	---
Shield		Stainless		
Cover		PBT resin	---	---
Sealing resin		---	Epoxy resin	---
O-rings		Rubber		---
Grounding fixture		---	Copper alloy/Tin plating	---
Anchor cover		---	Stainless	---
Nuts		---	Copper alloy/Nickel plating	---

● Cables

Item	Model	Standard Cable	Robot Cable	Shield Strengthening Model (Standard Cable)
Compliant standard		UL CM		
Category		Cat5e		
Core/color		AWG22 (7/0.26): Yellow · Orange · White · Blue	AWG22 (7/24/0.05): Yellow · Orange · White · Blue	AWG22 (7/0.26): Yellow · Orange · White · Blue
Outer diameter*1		6.5 dia.		
Sheath color*2		Light blue, Yellow		Black
Sheath material		PVC		
Shield structure		Double shield		

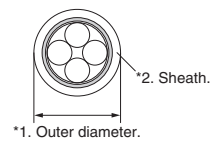

XS5/XS6

Dimensions

(Unit: mm)

● Cable with Plug on One End (M12 Straight)

XS5H-T421-□M0-K

Wiring

Terminal No.	Color	Signal
1	Yellow	TD+
2	White	RD+
3	Orange	TD-
4	Blue	RD-

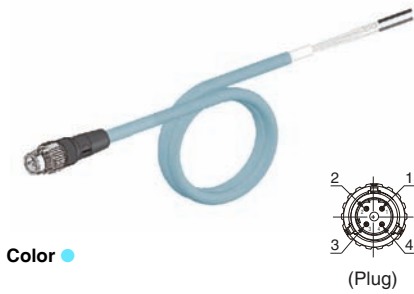

Color ●

● Cable with Plugs on Both End (M12 Straight/M12 Straight)

XS5W-T421-□M2-K
 XS5W-T421-□M2-KR
 XS5W-T421-□M2-Y
 XS5W-T421-□M2-YR

Wiring

M12 straight	M12 straight
1	1
2	2
3	3
4	4
Shield	Shield



Color ●●

● Cable with Plugs on Both Ends (M12 Straight/RJ45)

XS5W-T421-□MC-K
 XS5W-T421-□MC-KR
 XS5W-T421-□MC-Y
 XS5W-T421-□MC-YR

Wiring

M12 straight	RJ45
1	1
2	3
3	2
4	6
Shield	Shield



Color ●●

● Cable with Plug on One End and Socket on Other End (M12 Straight/M12 Straight)

XS5W-T421-□M1-K
 XS5W-T421-□M1-KR

Wiring

M12 straight	M12 straight
1	1
2	2
3	3
4	4
Shield	Shield



Color ●

● Cable with Plug on One End and Socket on Other End (M12 Straight/RJ45)

XS5W-T421-□ME-K

Wiring

M12 straight	RJ45
1	1
2	3
3	2
4	6
Shield	Shield

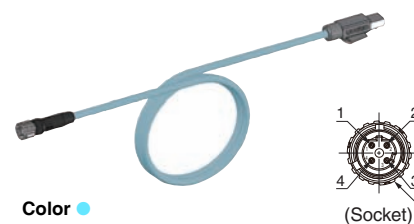

Color ●

● Cable with Socket on Both End (M12 straight/M12 straight)

XS5W-T421-□M3-K
XS5W-T421-□M3-YR



Color ●●

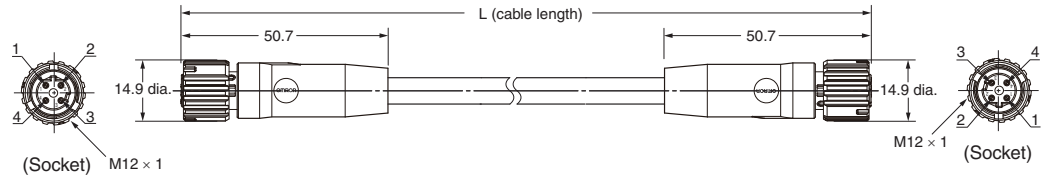

Wiring

M12 straight		M12 straight
1	—————	1
2	—————	2
3	—————	3
4	—————	4
Shield	—————	Shield

● Cable with Plug One End (M12 Right-angle)

XS5H-T422-□M0-K



Color ●

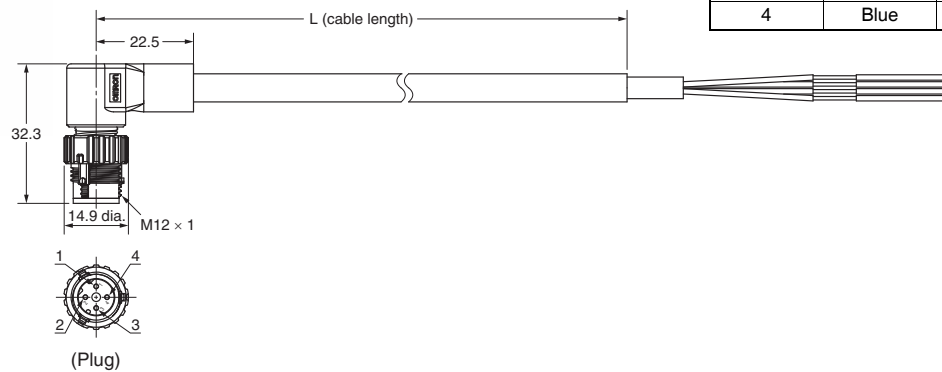

Wiring

Terminal No.	Color	Signal
1	Yellow	TD+
2	White	RD+
3	Orange	TD-
4	Blue	RD-

● Cable with Plugs on Both Ends (M12 Right-angle/M12 Right-angle)

XS5W-T422-□M2-K



Color ●

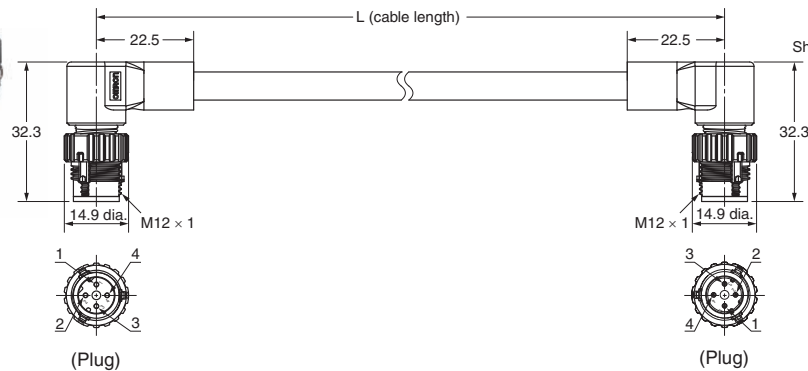

Wiring

M12 right angle		M12 right angle
1	—————	1
2	—————	2
3	—————	3
4	—————	4
Shield	—————	Shield

● Cable with Plugs on Both Ends (M12 Right-angle/RJ45)

XS5W-T422-□MC-K



Color ●

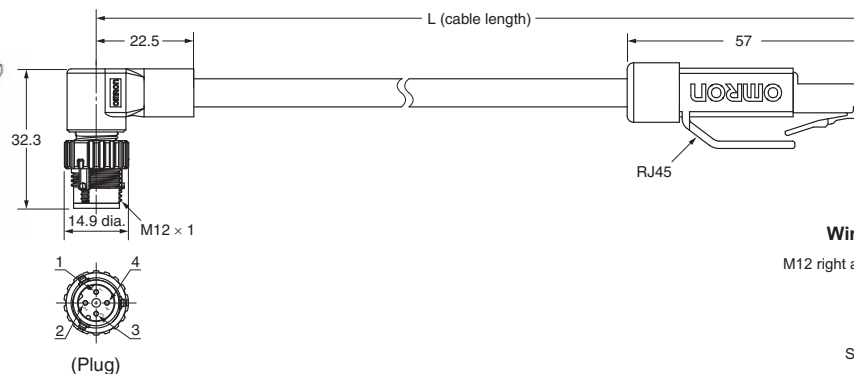

Wiring

M12 right angle		RJ45
1	—————	1
2	—————	3
3	—————	2
4	—————	6
Shield	—————	Shield

XS5/XS6

● Cable with Plugs on Both Ends (RJ45/RJ45)

XS5W-T421-□MD-K
 XS5W-T421-□MD-KR
 XS5W-T421-□MD-YR



Color ●●●

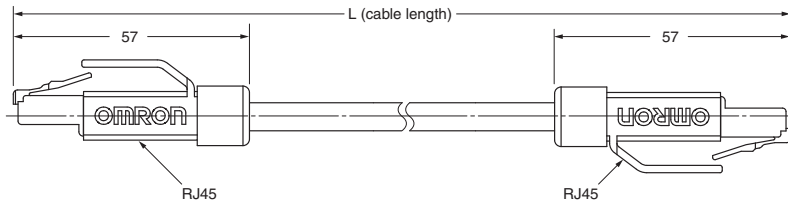

Wiring

RJ45	RJ45
1	1
2	2
3	3
6	6
Shield	Shield

● Cable with Plugs on Both Ends (M12 Straight/M12 Straight)

Shield Strengthening Model

XS5W-T421-□M2-SS



Color ●

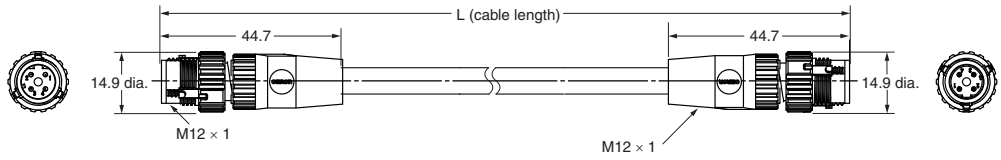

Wiring

M12 straight	M12 straight
1	1
2	2
3	3
4	4
Shield	Shield

● Cable with Plugs on Both Ends (M12 Straight/RJ45)

Shield Strengthening Model

XS5W-T421-□MC-SS



Color ●

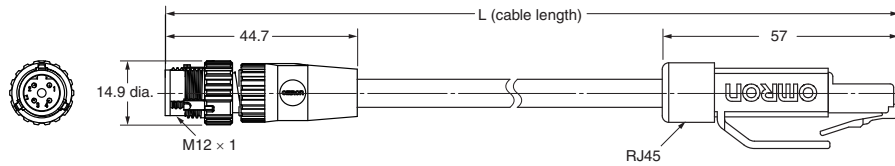

Wiring

M12 straight	RJ45
1	1
2	3
3	2
4	6
Shield	Shield

● RJ45 Assembly Connector
XS6G-T421-1

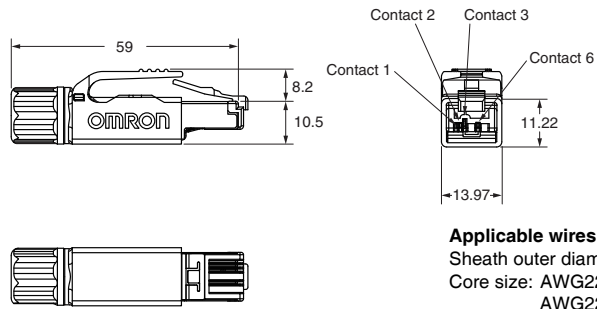

Applicable wires

Sheath outer diameter: 4.5 to 9.0 mm
Core size: AWG22 to AWG24 (stranded wires)
AWG22 to AWG23 (solid wires)
Insulation outer diameter: 1.6 mm max.

● M12 Connector for Panel Mounting
XS5P-T42□-5



XS5P-T426-5 (Rear Locking)
XS5P-T428-5 (Rear Locking, with connector anti-rotation mechanism)

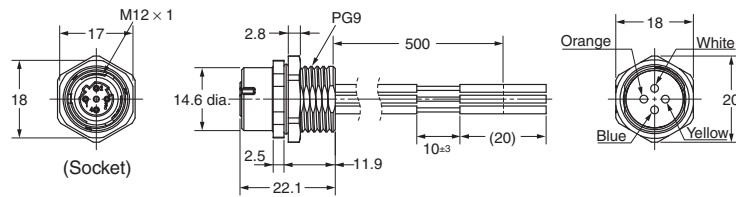

XS5P-T427-5 (Front Locking)

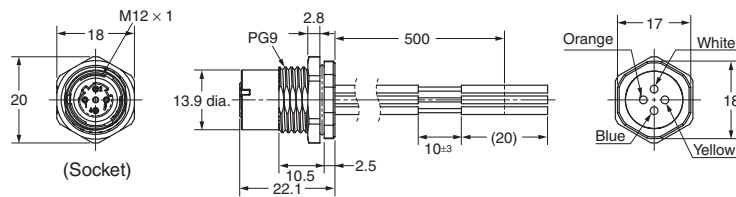

Wiring

Terminal No.	Color	Signal
1	Yellow	TD+
2	White	RD+
3	Orange	TD-
4	Blue	RD-

Panel Cutout Dimension

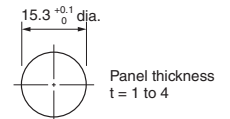

Note 1: The panel cutout dimension is the same for Front-locking and Rear-locking Connectors.

Note 2: Rotational positioning is not possible for connector rotation.

● M12 Panel-mounting PCB Straight Terminals
XS5P-T426-1

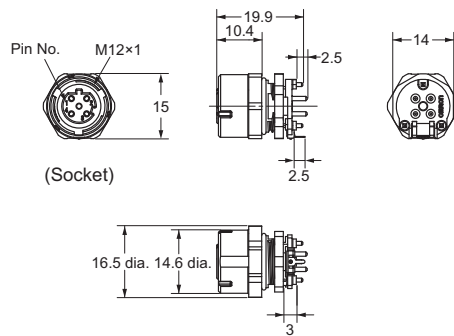

Mounting Hole Dimensions (D Cut Structure)

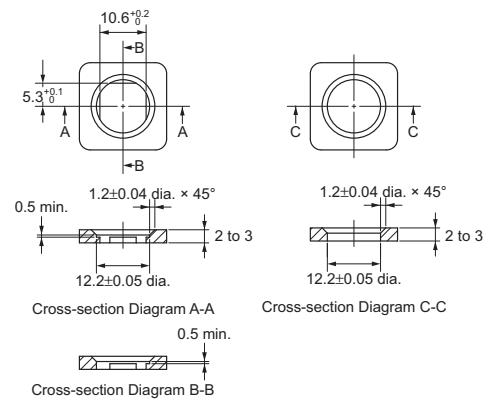

Panel Processing Dimensions

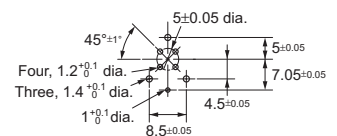

XS5/XS6

Assembly Procedure

● RJ45 Assembly Connectors

XS6G-T421-1

1. Pass the cable through the cable clamp and the connector housing
2. Strip the cable sheath and ground braiding to the correct lengths.
3. Follow the color codes and prepare to insert the wires into the splice piece.
4. Insert the wires into the splice piece for the length of the splice piece.
5. Place the splice piece into the RJ45 data module and engage it.
6. Place the data module and the splice piece on the IDC assembly housing.
7. Press the data module and the IDC assembly housing together and use pliers or a similar device to make the insulation displacement contact.
8. Remove the data module from the IDC assembly housing.
9. Place the upper screen plate on the data module and press it over the ground braiding of the cable.
10. Place the lower screen plate on the bottom of the data module, align it with the upper screen plate, and latch it until you hear it click into place.
11. Slide the housing that you placed around the cable in step 1 up to the data module and latch it until you hear it click into place.
12. Tighten the cable clamp.

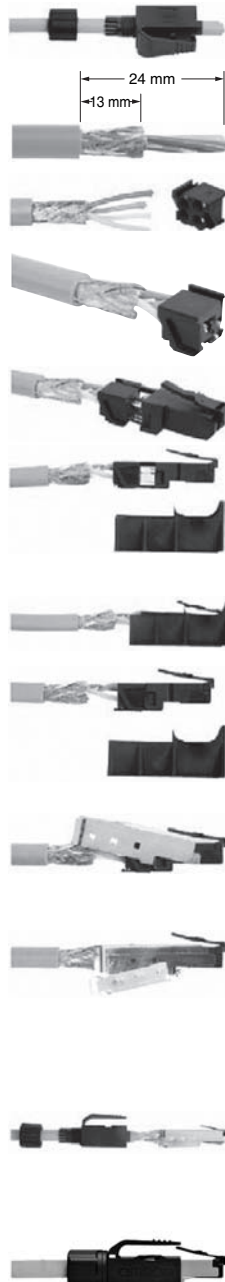

Pin Assignments

Pin Assignments for Fast Ethernet 10/100 Mbps

Function/Signal	Wire color			Pin No.
	Industrial Ethernet	EIA/TIA 568A	EIA/TIA 568B	
Transmission Data+/TD+	YE	WH/GN	WH/OG	1
Transmission Data-/TD-	OG	GN	OG	2
Receiver Data/RD+	WH	WH/OG	WH	3
Receiver Data/RD-	BU	OG	GN	6

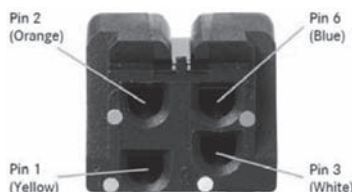

● M12 Panel-mounting PCB Straight Terminals

XS5P-T426-1

Confirming the Number of Parts

The following four parts are included in the package when it is delivered.

Panel-mounting Parts

1. Anchor

2. O-Ring

3. Nut

PCB-mounting Part

4. Connector



Assembly Procedure

1. Mount the connector to the PCB.

2. Attach the anchor to the panel with the nut.

Mounting the Connector to the PCB

Mounting the Anchor to the Panel

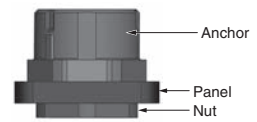
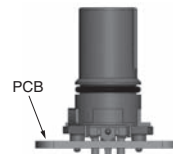

*Tightening torque: 1 N·m

3. Attach the connector that you mounted to the PCB to the panel.

* Make sure that the connector and anchor are oriented correctly.

Attachment

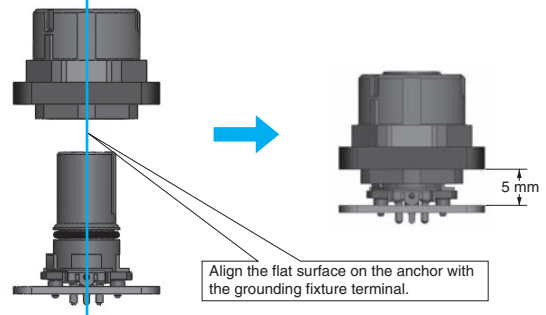

4. Temporarily mount the O-ring to the top of the connector at the mating surface.

Temporary Mounting of the O-Ring

O-ring



5. Mate the Connector Waterproof Cover (XS2Z-22, sold separately) or the Partner Connector Plug (XS5H-T42□-□M0-K, sold separately) and press the O-ring to the O-ring position after mounting.

Mounting the O-Ring

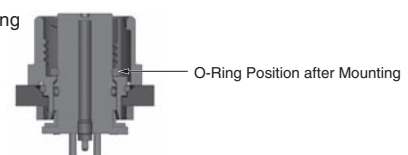

● Connector Waterproof Cover (Sold Separately)

XS2Z-22

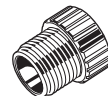

* Tightening torque: 0.39 to 0.49 N·m

List of Main Types of Cables with Connectors

● XS6 Series

Connectors on both ends		Cables	Sheath material	Sheath color	Cable specifications	Cable length (m)												Model number structure	
Connectors (1)	Connectors (2)					0.2	0.3	0.5	1	1.5	2	3	5	7.5	10	15	20		
RJ45 plug	RJ45 plug	Cat6A, AWG26x4Pairs	PUR	Yellow	Flexibility improved	20	30	50	100	150	200	300	500	750	1000	1500	2000	XS6W-6PUR8SS[...]	CM-YF
			LSZH	Blue	Standard	20	30	50	100	150	200	300	500	750	1000	1500	2000	XS6W-6LSZH8SS[...]	CM-B
				Yellow	Standard	20	30	50	100	150	200	300	500	750	1000	1500	2000	XS6W-6LSZH8SS[...]	CM-Y
				Green	Standard	20	30	50	100	150	200	300	500	750	1000	1500	2000	XS6W-6LSZH8SS[...]	CM-G
		Cat5, AWG26x4Pairs	PUR	Green	Standard	---	---	50	100	150	200	300	500	750	1000	1500	2000	XS6W-5PUR8SS[...]	CM-G

Note. The numerals indicating the cable length as shown in the table are entered at the [...] position in the model number structure.

● XS5□-T Series

Connectors on both ends		Cables	Sheath material	Sheath color	Cable specifications	Cable length (m)																				Model number structure										
Connectors (1)	Connectors (2)					0.3	0.5	1	1.5	2	2.5	3	3.5	4	4.5	5	10	15	20	25	30	35	40	45	50											
RJ45 plug	RJ45 plug	Cat5e, AWG22 x 2Pairs	PVC	Light blue	Standard	A	B	C	---	D	---	E	---	---	G	J	K	L	T	N	Z	P	R	X	XS5W-T421-[...]	MD-K										
				Light blue	Flexible robot	---	B	C	Y	D	U	E	V	F	W	G	J	K	L	T	N	---	---	---	---	---	---	---	X	XS5W-T421-[...]	MD-KR					
				Yellow	Flexible robot	---	B	C	---	D	---	E	---	---	---	G	---	---	---	---	---	---	---	---	---	---	---	---	---	X	XS5W-T421-[...]	MD-YR				
RJ45 plug	M12 plug Straight			Light blue	Standard	A	B	C	Y	D	U	E	V	F	W	G	J	K	L	T	N	---	---	---	---	---	---	---	X	XS5W-T421-[...]	MC-K					
				Yellow	Standard	A	B	C	---	D	---	E	---	---	---	G	---	---	---	---	---	---	---	---	---	---	---	---	---	---	X	XS5W-T421-[...]	MC-Y			
				Black	Standard	---	B	C	---	D	---	E	---	---	---	G	J	---	---	---	---	---	---	---	---	---	---	---	---	---	---	X	XS5W-T421-[...]	MC-SS		
				Light blue	Flexible robot	---	B	C	Y	D	U	E	V	F	W	G	J	K	L	T	N	---	---	---	---	---	---	---	---	---	---	---	X	XS5W-T421-[...]	MC-KR	
				Yellow	Flexible robot	---	---	---	---	---	---	E	---	---	---	G	J	K	L	T	---	---	---	---	---	---	---	---	---	---	---	---	X	XS5W-T421-[...]	MC-YR	
						Light blue	Standard	A	B	C	Y	D	U	E	V	---	---	G	J	K	---	---	---	---	---	---	---	---	---	---	---	---	---	X	XS5W-T422-[...]	MC-K
RJ45 plug	M12 socket Straight			Light blue	Standard	---	B	C	Y	D	U	E	V	F	W	G	J	K	L	T	N	---	---	---	---	---	---	---	---	---	---	X	XS5W-T421-[...]	ME-K		
M12 plug Straight	M12 plug Straight			Light blue	Standard	---	B	C	Y	D	U	E	V	F	W	G	J	K	L	T	N	---	---	---	---	---	---	---	---	---	---	X	XS5W-T421-[...]	M2-K		
				Yellow	Standard	A	B	C	---	D	---	E	---	---	---	G	---	---	---	---	---	---	---	---	---	---	---	---	---	---	---	---	X	XS5W-T421-[...]	M2-Y	
				Black	Standard	---	B	C	---	D	---	E	---	---	---	G	J	---	---	---	---	---	---	---	---	---	---	---	---	---	---	---	X	XS5W-T421-[...]	M2-SS	
				Light blue	Flexible robot	---	B	C	Y	D	U	E	V	F	W	G	J	K	L	T	N	---	---	---	---	---	---	---	---	---	---	---	---	X	XS5W-T421-[...]	M2-KR
				Yellow	Flexible robot	---	---	C	---	D	---	E	---	---	---	G	J	K	---	---	---	---	---	---	---	---	---	---	---	---	---	---	---	X	XS5W-T421-[...]	M2-YR
						Light blue	Standard	A	B	C	Y	D	---	E	---	---	---	G	J	K	---	---	---	---	---	---	---	---	---	---	---	---	---	---	X	XS5W-T422-[...]
M12 socket Straight	M12 socket Straight			Light blue	Standard	---	---	C	---	D	---	---	---	---	---	---	---	---	---	---	---	---	---	---	---	---	---	---	---	---	---	---	X	XS5W-T421-[...]	M3-K	
				Yellow	Flexible robot	---	B	---	---	---	---	---	---	---	---	---	---	---	---	---	---	---	---	---	---	---	---	---	---	---	---	---	---	---	X	XS5W-T421-[...]
M12 plug Straight	M12 socket Straight			Light blue	Standard	---	B	C	Y	D	U	E	V	F	W	G	J	K	L	T	N	---	---	---	---	---	---	---	---	---	---	---	---	X	XS5W-T421-[...]	M1-K
				Light blue	Flexible robot	---	B	C	Y	D	U	E	V	F	W	G	J	K	L	T	N	---	---	---	---	---	---	---	---	---	---	---	---	---	X	XS5W-T421-[...]

Connectors on one end		Cables	Sheath material	Sheath color	Cable specifications	Cable length (m)																				Model number structure							
Connectors (1)	Connectors (2)					0.3	0.5	1	1.5	2	2.5	3	3.5	4	4.5	5	10	15	20	25	30	35	40	45	50								
M12 plug Straight	---	Cat5e, AWG22 x 2Pairs	PVC	Light blue	Standard	---	B	C	---	D	---	E	---	---	---	G	J	K	---	---	---	---	---	---	---	---	---	---	---	---	X	XS5H-T421-[...]	JM0-K
M12 plug Right angle	---			Light blue	Standard	A	B	C	---	D	---	E	---	---	---	---	G	J	K	---	---	---	---	---	---	---	---	---	---	---	---	---	X

Note. The alphabet indicating the cable length as shown in the table is entered at the [...] position in the model number structure.

Safety Precautions

Definitions of Precautions

Precautions for Safe Use	These refer to actions that should be performed or refrained from in order to ensure safe product usage.
Precautions for Correct Use	These refer to actions that should be performed or refrained from in order to prevent product breakage, malfunctioning, and negative effects to performance and functionality.

Precautions for Safe Use

Degree of Protection

Do not use these products if their protective structures have deteriorated, such as swelling or breakage of housing and sealing components.

If products with deteriorated protective structures continue to be used, breakage or fire damage, etc., may occur.

Connector Connection and Disconnection

- When connecting or disconnecting Connectors, be sure to hold the Connectors by hand.
- Do not hold the cable when disconnecting Connectors. Use after confirming the direction of the polarity key groove.
- Do not touch wiring with wet hands. Doing so may result in malfunction or breakage when the device is turned on.
- When mating Connectors, be sure to insert the plug all the way to the back of the socket before attempting to lock the Connectors. After operating the lock, always confirm that the Connector is connected.
- Do not use tools of any sort to mate the Connectors. Always use your hands. Pliers or other tools may damage the Connectors.
- When replacing the Connector, confirm that no foreign substances such as liquids or cutting oils are adhered to the connection surface of the Connector before connecting.

Disposal

Dispose of this product as industrial waste.

Precautions for Correct Use

- Do not use the Connectors in an atmosphere or environment that exceeds the specifications.
- Do not perform wiring while power is flowing. Doing so may result in electrical shock or device breakage.
- Do not use the Connectors in an environment where corrosive gases or high temperature/high humidity are present. Doing so may result in malfunctions such as connection/contact failures and corrosion.
- Do not pull excessively on the Connectors or cables.
- Do not step on or place any objects on the Connectors. Doing so may damage the Connectors.
- Install the Connectors in a location where they will not be stepped on, to prevent disconnection of the cables or damage to the Connectors. If the Connectors or cables must be installed where they might be stepped on, protect them with covers.
- If a sensor or switch is not attached during installation, or if the plug connector is not engaged, use a waterproof cover or dust cover to protect the mating surface of the connector.

Wiring

- Do not perform wiring in environments where the cable ends may be exposed to liquids such as water or cutting oils.
- Follow the wiring diagrams when wiring the cables. Confirm that connections are possible before use.
- Lay the cables so that external force is not applied to the Connectors. Otherwise, the degree of protection may not be achieved.

Degree of Protection (IP67)

- The degree of protection of Connectors (IP67) is not for a fully watertight structure. Do not use the Connectors underwater.

Setup

- Do not install the Connectors or cables in any way that would place a load directly on the mating section or cable connections. Doing so can damage the Connectors or break the wires inside the cables.
- If bending XS5H/W-T cable, ensure that the minimum bend radius is 40 mm.

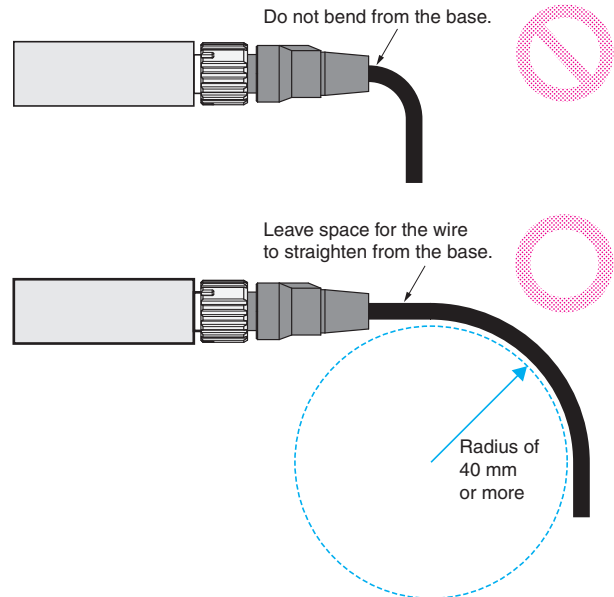

- If bending XS6W-6LSZH/5PUR cable, ensure that the minimum bend radius is 25 mm.

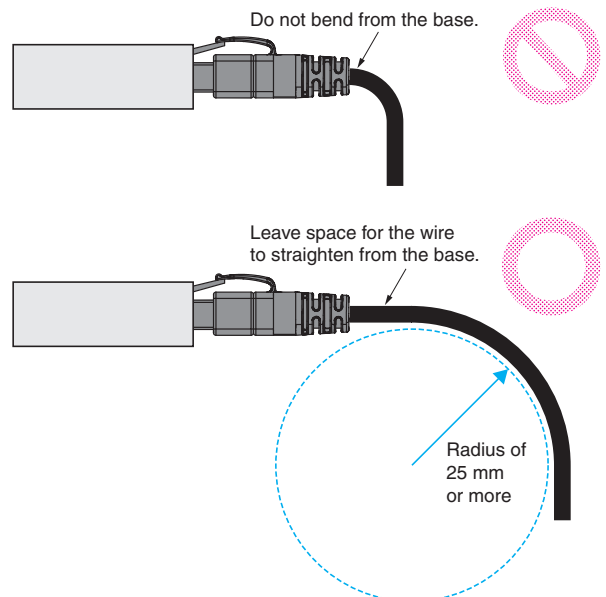

- If bending XS6W-6PUR cable, ensure that the minimum bend radius is 52 mm.

Terms and Conditions Agreement

Read and understand this catalog.

Please read and understand this catalog before purchasing the products. Please consult your OMRON representative if you have any questions or comments.

Warranties.

- (a) Exclusive Warranty. Omron's exclusive warranty is that the Products will be free from defects in materials and workmanship for a period of twelve months from the date of sale by Omron (or such other period expressed in writing by Omron). Omron disclaims all other warranties, express or implied.
- (b) Limitations. OMRON MAKES NO WARRANTY OR REPRESENTATION, EXPRESS OR IMPLIED, ABOUT NON-INFRINGEMENT, MERCHANTABILITY OR FITNESS FOR A PARTICULAR PURPOSE OF THE PRODUCTS. BUYER ACKNOWLEDGES THAT IT ALONE HAS DETERMINED THAT THE PRODUCTS WILL SUITABLY MEET THE REQUIREMENTS OF THEIR INTENDED USE.

Omron further disclaims all warranties and responsibility of any type for claims or expenses based on infringement by the Products or otherwise of any intellectual property right. (c) Buyer Remedy. Omron's sole obligation hereunder shall be, at Omron's election, to (i) replace (in the form originally shipped with Buyer responsible for labor charges for removal or replacement thereof) the non-complying Product, (ii) repair the non-complying Product, or (iii) repay or credit Buyer an amount equal to the purchase price of the non-complying Product; provided that in no event shall Omron be responsible for warranty, repair, indemnity or any other claims or expenses regarding the Products unless Omron's analysis confirms that the Products were properly handled, stored, installed and maintained and not subject to contamination, abuse, misuse or inappropriate modification. Return of any Products by Buyer must be approved in writing by Omron before shipment. Omron Companies shall not be liable for the suitability or unsuitability or the results from the use of Products in combination with any electrical or electronic components, circuits, system assemblies or any other materials or substances or environments. Any advice, recommendations or information given orally or in writing, are not to be construed as an amendment or addition to the above warranty.

See <http://www.omron.com/global/> or contact your Omron representative for published information.

Limitation on Liability; Etc.

OMRON COMPANIES SHALL NOT BE LIABLE FOR SPECIAL, INDIRECT, INCIDENTAL, OR CONSEQUENTIAL DAMAGES, LOSS OF PROFITS OR PRODUCTION OR COMMERCIAL LOSS IN ANY WAY CONNECTED WITH THE PRODUCTS, WHETHER SUCH CLAIM IS BASED IN CONTRACT, WARRANTY, NEGLIGENCE OR STRICT LIABILITY.

Further, in no event shall liability of Omron Companies exceed the individual price of the Product on which liability is asserted.

Suitability of Use.

Omron Companies shall not be responsible for conformity with any standards, codes or regulations which apply to the combination of the Product in the Buyer's application or use of the Product. At Buyer's request, Omron will provide applicable third party certification documents identifying ratings and limitations of use which apply to the Product. This information by itself is not sufficient for a complete determination of the suitability of the Product in combination with the end product, machine, system, or other application or use. Buyer shall be solely responsible for determining appropriateness of the particular Product with respect to Buyer's application, product or system. Buyer shall take application responsibility in all cases.

NEVER USE THE PRODUCT FOR AN APPLICATION INVOLVING SERIOUS RISK TO LIFE OR PROPERTY OR IN LARGE QUANTITIES WITHOUT ENSURING THAT THE SYSTEM AS A WHOLE HAS BEEN DESIGNED TO ADDRESS THE RISKS, AND THAT THE OMRON PRODUCT(S) IS PROPERLY RATED AND INSTALLED FOR THE INTENDED USE WITHIN THE OVERALL EQUIPMENT OR SYSTEM.

Programmable Products.

Omron Companies shall not be responsible for the user's programming of a programmable Product, or any consequence thereof.

Performance Data.

Data presented in Omron Company websites, catalogs and other materials is provided as a guide for the user in determining suitability and does not constitute a warranty. It may represent the result of Omron's test conditions, and the user must correlate it to actual application requirements. Actual performance is subject to the Omron's Warranty and Limitations of Liability.

Change in Specifications.

Product specifications and accessories may be changed at any time based on improvements and other reasons. It is our practice to change part numbers when published ratings or features are changed, or when significant construction changes are made. However, some specifications of the Product may be changed without any notice. When in doubt, special part numbers may be assigned to fix or establish key specifications for your application. Please consult with your Omron's representative at any time to confirm actual specifications of purchased Product.

Errors and Omissions.

Information presented by Omron Companies has been checked and is believed to be accurate; however, no responsibility is assumed for clerical, typographical or proofreading errors or omissions.

Smartclick is a registered trademark of OMRON Corporation.

Sysmac is a trademark or registered trademark of OMRON Corporation in Japan and other countries for OMRON factory automation products.

EtherCAT® is a registered trademark of Beckhoff Automation GmbH for their patented technology.

EtherNet/IP™ and DeviceNet™ are trademarks of ODVA.

Note: Do not use this document to operate the Unit.

OMRON Corporation Industrial Automation Company
Kyoto, JAPAN

Contact: www.ia.omron.com

Regional Headquarters

OMRON EUROPE B.V.

Wegalaan 67-69, 2132 JD Hoofddorp
The Netherlands

Tel: (31)2356-81-300/Fax: (31)2356-81-388

OMRON ELECTRONICS LLC

2895 Greenspoint Parkway, Suite 200
Hoffman Estates, IL 60169 U.S.A.

Tel: (1) 847-843-7900/Fax: (1) 847-843-7787

OMRON ASIA PACIFIC PTE. LTD.

438B Alexandra Road, #08-01/02 Alexandra
Technopark, Singapore 119968

Tel: (65) 6835-3011/Fax: (65) 6835-2711

OMRON (CHINA) CO., LTD.

Room 2211, Bank of China Tower,
200 Yin Cheng Zhong Road,
PuDong New Area, Shanghai, 200120, China

Tel: (86) 21-5037-2222/Fax: (86) 21-5037-2200

Authorized Distributor:

© OMRON Corporation 2010-2022 All Rights Reserved.
In the interest of product improvement,
specifications are subject to change without notice.

CSM_10_4

Cat. No. G019-E1-16

0522 (0710)