

Smart Sensors Laser Sensors CMOS Type ZX2

CSM_ZX2_DS_E_6_3

Stable measurement that is unaffected by workpiece changes. The simple setting for everyone.



- High-precision measurement to approx. 10 μm .
- Stable measurement regardless of movement or changes in workpiece color or material.
- Smart tuning for optimal setting with one button for essentially any user.
- The 11-segment display enables reading characters at a glance.
- Four built-in banks make changeovers easy.
- Stable measurement in harsh environments with IP67 protection for Sensor Head and robot cable.
- Laser life indicator to prevent line stoppage through visualization.



For the most recent information on models that have been certified for safety standards, refer to your OMRON website.

Be sure to read *Safety Precautions* on page 11

Features

Stability

Measurements to a Precision in the Order of 10 μm for any Workpiece

Stable measurement even for changes in colors and materials or for moving workpieces with CMOS that has a dynamic range of two million times **Patented***2

The use of a unique OMRON HSDR-CMOS (high-speed and dynamic range) image sensor and a step-less laser power adjustment algorithm enable stable measurements for any color or surface conditions, from metals to substrates, rubber, and transparent objects. Linearity of $\pm 0.05\text{--}0.3\%$ F.S. achieves a measurement precision in the order of $\pm 10\text{--}30\mu\text{m}$.*1

Stable measurements on objects with changing color/material

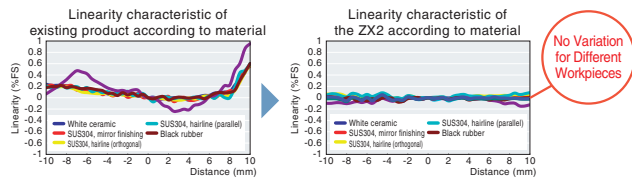
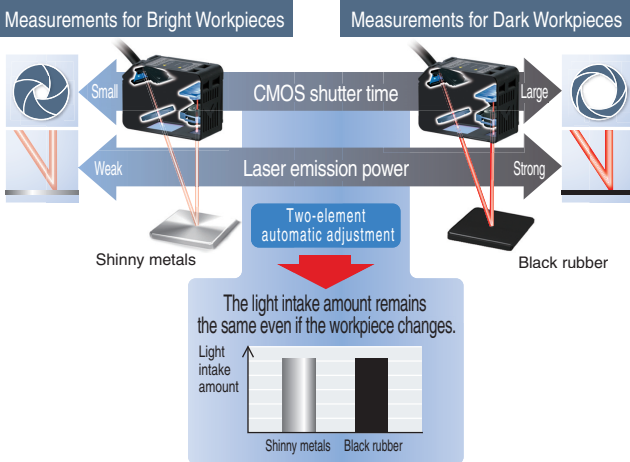

Stable measurements on moving objects

A line beam is used in addition to an emitter beam when dealing with rough surfaces to average out the amount of reflected light and to offset the amount of light received at a high-speed measurement period of 30 μs in order to reduce variations in received light and to enable stable measurements for moving objects.

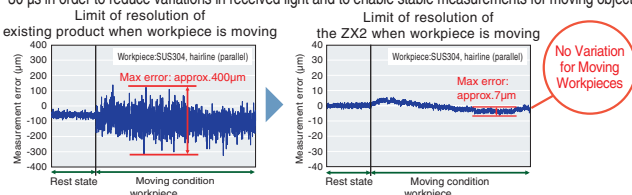

*1. The resolution, angle characteristic, measuring range, linearity, spot diameter, and other specifications differ among models. Refer to *Ratings and Specifications* for details. The linearity indicates the error with respect to the ideal straight line of the displacement output in the case of measuring Omron's standard target object. Linearity and measured value may vary depending on target object. Before final installation, test the sensor required for the application to validate that the desired measurements have been obtained.
*2. "Patented" means that we obtained a patent in Japan. (As of October 2019)

Easy

Essentially Anyone Can Set Optimum Conditions

Easily select smart tuning with one button. **Patented***2

The optimum settings for stable measurement can be achieved with one smart tuning button. The settings will not rely on the skill of the user.

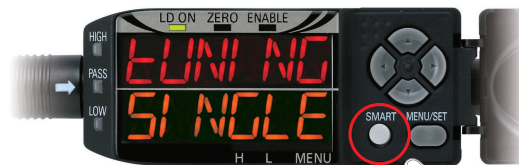

Sensor configuration by just a pushing the SMART button

Three selectable tunings

More accurate settings are made possible by the three tuning methods for different workpiece types and surface conditions.

Scene.1

One type of workpiece



Single smart tuning
Best configuration for stable detection in case of objects do not change by pushing the button for one second

Scene.2

Several types of workpiece



Multi-smart tuning
Ideal configuration for stable detection of changing objects by pushing the button for three seconds

Scene.3

Surface conditions of the workpiece are variable



Active smart tuning
Continuous configuration improvement for the stable detection of all locations by pushing the button for five seconds

Ordering Information

Units

Sensor Heads [\[Dimensions → page 11\]](#)

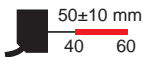
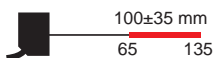
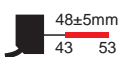
Appearance	Sensing method	Beam shape	Sensing distance	Resolution	Model
	Diffuse-reflective	Line beam	 50±10 mm	1.5 μm	ZX2-LD50L 0.5M
		Spot beam	40 60		ZX2-LD50 0.5M
		Line beam	 100±35 mm	5 μm	ZX2-LD100L 0.5M
		Spot beam	65 135		ZX2-LD100 0.5M
	Regular-reflective	Spot beam	 48±5mm	1.5 μm	ZX2-LD50V 0.5M

Amplifier Units [\[Dimensions → page 11\]](#)

Appearance	Power supply	Output type	Model
	DC	NPN	ZX2-LDA11 2M
		PNP	ZX2-LDA41 2M

Accessories (sold separately) These are not included with the Sensor Head or Amplifier Unit. Please order as necessary.

Calculating Unit [\[Dimensions → page 12\]](#)

Appearance	Model
	ZX2-CAL

Communications Interface Unit [\[Dimensions → page 12\]](#)



Appearance	Type	Model
	RS-232C	ZX2-SF11

Sensor Head Extension Cables [\[Dimensions → page 12\]](#)

Cable Length	Model
1 m	ZX2-XC1R
4 m	ZX2-XC4R
9 m	ZX2-XC9R
20 m	ZX2-XC20R

Note: Extension cables cannot be coupled and used together.

Mounting Brackets [\[Dimensions → page 13\]](#)

Applicable Sensor Head	Appearance	Model	Remarks
ZX2-LD50V ZX2-LD50L ZX2-LD50		E39-L178	Mounting Brackets (1) Nut Plate (1) Phillips screws (M30 × 30) (2)
ZX2-LD100L ZX2-LD100		E39-L179	

Sensor Head

Sensor Heads for Various Applications-select the Range and Type of Beam

New Regular-reflective Sensor Head Designed for Optimal Wafer Measurement

ZX2-LD50L Line beam type
ZX2-LD50 Spot beam type

● Measurement range	50mm ±10mm
● Resolution	1.5 μm
● Linearity	Line beam ±0.05%F.S.*1 Spot beam ±0.10%F.S.*1
● Beam size	Line beam Approx.60μm×2.6mm Spot beam Approx.60μm dia.

ZX2-LD50V Spot beam type (regular-reflective)

● Measurement range	48mm ±5mm
● Resolution	1.5 μm
● Linearity	Spot beam ±0.3%F.S.
● Beam size	Spot beam Approx.60μm dia.

ZX2-LD100L Line beam type
ZX2-LD100 Spot beam type

● Measurement range	100mm ±35mm
● Resolution	5 μm
● Linearity	Line beam ±0.05%F.S.*2 Spot beam ±0.10%F.S.*2
● Beam size	Line beam Approx.110μm×2.7mm Spot beam Approx.110μm dia.

Spot beam

Precise measurement on micro-scale objects

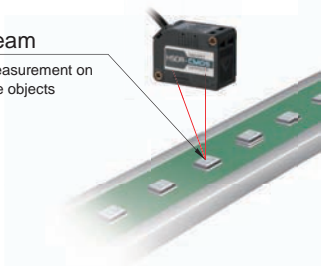

Regular-reflective

Stable wafer measurement

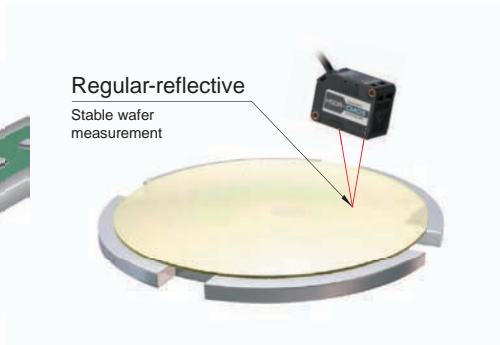

Line beam

Stable measurement on rough-surfaced objects

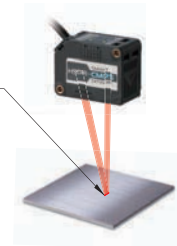

*1 Using 40 to 50mm
*2 Using 65 to 100mm

Reliable measurements in harsh environments

IP67, robot cable & temperature characteristic 0.02% F.S./°C

IP67 protection class enables to use the sensor in harsh environments. A robot cable is used as standard between the head and amplifier, that the unit can be used reliably on moving parts. In addition, as 3D UV bond is used to fix the optical components rather than screws, stress can be controlled and a temperature characteristic 0.02% F.S./°C* is realized.

* If the room temperature varies 1°C, the measured value varies 0.02% F.S. (corresponding to 4μm for the Model ZX2-LD50)



Compact sensor for easy mounting

World smallest*

The world's smallest CMOS laser displacement sensor head is realized in a resin case. Enables to mount the sensor in smallest spaces and to minimize measurement errors arising from temperature fluctuations.

* According to OMRON investigation of CMOS laser displacement sensors performed in September 2010.

Cable can be fed through from the back

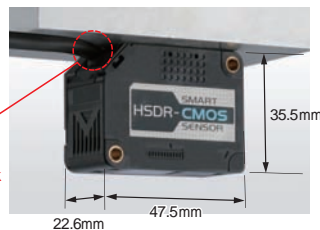

Amplifier and Calculating Unit

Ease of Use by “LED Display” and “Calculating Unit”

11-segment LED display for intuitive configuration



Easy calculations of measurements

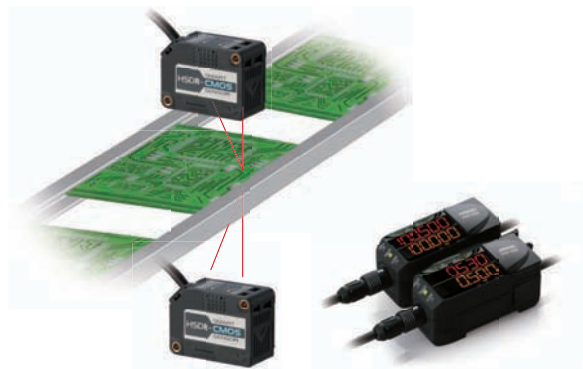

No need for a manual

11 Segment LED Display

An 11 segment LED display is integrated in the compact housing. Alphanumeric characters can be read with ease and there is no need to refer to a manual.



Comparison of the existing 7 segment LED display and the 11 segment LED display

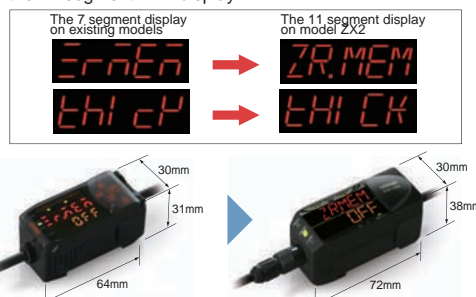

The compact housing stays just as it is

Perform two calculations with ease

Thickness + subtraction mode

The calculated results of two sensor heads are displayed on the amplifier unit by just connecting the calculating unit between the two amplifier units. The calculation function can be chosen from the two modes of thickness and subtraction. It is also possible to prevent mutual interference by coupling via the calculating units. (Up to five amplifier units can be connected.)

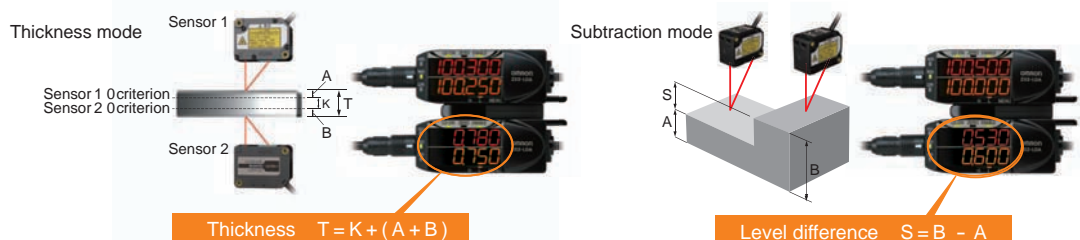

Easy change of setup

Equipped with 4 banks

The amplifier unit is equipped with four bank functions. Easy change of setup between four modes is supported by just switching between the bank functions.



Specifications

Diffuse-reflective Sensor Heads

Item	Model	ZX2-LD50L	ZX2-LD50	ZX2-LD100L	ZX2-LD100
Optical system		Diffuse reflective			
Light source (wave length)		Visible-light semiconductor laser with a wavelength of 660 nm and an output of 1mW max. EN class 2, FDA class 2 *5			
Measurement center point		50 mm		100 mm	
Measurement range		±10 mm		±35 mm	
Beam shape		Line	Spot	Line	Spot
Beam size *1		Approx. 60 μm × 2.6 mm	Approx. 60 μm dia.	Approx. 110 μm × 2.7 mm	Approx. 110 μm dia.
Resolution *2		1.5 μm		5 μm	
Linearity *3		±0.05% F.S. (40 to 50 mm)	±0.1% F.S. (40 to 50 mm)	±0.05% F.S. (65 to 100 mm)	±0.1% F.S. (65 to 100 mm)
Temperature characteristic *4		0.02% F.S./°C			
Ambient illumination		Incandescent lamp: 10,000 lx max. (on light receiving side)			
Ambient temperature		Operating: 0 to 50 °C, Storage: -15 to 70 °C (with no icing or condensation)			
Ambient humidity		Operating and storage: 35% to 85% (with no condensation)			
Dielectric strength		1,000 VAC, 50/60 Hz for 1 min.			
Vibration resistance (destruction)		10 to 150 Hz, 0.7-mm double amplitude, 80 min. each in X, Y, and Z directions			
Shock resistance (destruction)		300 m/s ² 3 times each in six directions (up/down, left/right, forward/backward)			
Degree of protection		IEC60529, IP67			
Connection method		Connector connection (standard cable length: 500 mm)			
Weight (packed state)		Approx. 160 g (main unit only: Approx. 75 g)			
Materials		Case and cover: PBT (polybutylene terephthalate), Optical window: Glass, Internal thread: Brass, Cable: PVC			
Accessories		Instruction sheet, Ferrite core ×1 (made by TDK Corp. ZCAT1730-0730A), Laser warning label (English), FDA			

Regular-reflective Sensor Head

Item	Model	ZX2-LD50V
Optical system		Regular reflective
Light source (wave length)		Visible-light semiconductor laser with a wavelength of 660 nm and an output of 0.24 mW max. EN class 1, FDA class 1 *5
Measurement center point		48mm
Measurement range		±5mm
Beam shape		Spot
Beam size *1		Approx. 60 μm dia.
Resolution *2		1.5 μm
Linearity *3		±0.3%F.S. (entire range)
Temperature characteristic *4		0.06%F.S./°C
Ambient illumination		Incandescent lamp: 10,000lx max. (on light receiving side)
Ambient temperature		Operating: 0 to 50 °C, Storage: -15 to 70 °C (with no icing or condensation)
Ambient humidity		Operating and storage: 35% to 85% (with no condensation)
Dielectric strength		1,000 VAC, 50/60 Hz for 1 minute
Vibration resistance (destruction)		10 to 150 Hz, 0.7-mm double amplitude, 80 minutes, each in X,Y,and Z directions
Shock resistance (destruction)		300 m/s ² 3 times each in six directions (up/down,left/right,forward/backward)
Degree of protection		IEC 60529, IP67
Connection method		Connector connection (standard cable length: 500 mm)
Weight (packed state)		Approx.160g (Sensor Head only: Approx.75g)
Materials		Case and cover: PBT (polybutylene terephthalate), Optical window: Glass, Internal thread: Brass, Cable: PVC
Accessories		Instruction sheet, Ferrite core ×1 (made by TDK Corp. ZCAT1730-0730A), Laser warning label (English), FDA

Note: False detection outside the measurement range can occur in the case of an object with high reflectance.

- *1. Beam size: Defined as $1/e^2$ (13.5 %) of the center optical intensity at the minimum value of the measurement range (effective value).
False detections can occur in the case there is light leakage outside the defined region and the surroundings of the target object have a high reflectance in comparison to the target object. Correct measurements may not be obtained if the workpiece is smaller than the beam size.
- *2. Resolution: indicates the degree of fluctuation ($\pm 3\sigma$) of analog output when connected to the ZX2-LDA.
(The measured value is given for the center distance for OMRON's standard target object (diffuse-reflective models: white ceramic object, regular-reflective models: $1/4 \lambda$ flat mirror) when the response time of the ZX2-LDA is set to 128 ms.)
Indicates the repetition accuracy for when the workpiece is in a state of rest. Not an indication of distance accuracy.
Resolution performance may not be satisfied in a strong electromagnetic field.
- *3. Linearity: indicates the error with respect to the ideal straight line of the displacement output in the case of measuring Omron's standard target object. Linearity and measured value may vary depending on target object.
F.S. indicates the full scope of the measurement range. (ZX2-LD50(L): 20 mm)
- *4. Temperature characteristic: Value for the case the space between the sensor head and Omron's standard target object is secured by an aluminum jig. (Measured at the measurement center distance)
- *5. These Sensors are classified as Class 2 laser devices for diffuse-reflective models and Class 1 for regular-reflective models under EN 60825-1 and the regulations of Laser Notice No. 50 for FDA certification. CDRH registration has been completed.

Amplifier Units

Item	Model	ZX2-LDA11	ZX2-LDA41
Measurement period *1		Min. 30 μ s	
Response time		60 μ s, 120 μ s, 240 μ s, 500 μ s, 1 ms, 2 ms, 4 ms, 8 ms, 12 ms, 20 ms, 36 ms, 66 ms, 128 ms, 250 ms, 500ms	
Analog output *2		4 to 20 mA, Max. load resistance: 300 Ω ±5 VDC or 1 to 5 VDC, Output impedance: 100 Ω	
Judgement outputs (HIGH/PASS/LOW: 3 outputs), error output		NPN open-collector outputs, 30 VDC, 50 mA max. (residual voltage: 1 V max. for load current 10 mA max., 2V max. for load current above 10 mA)	PNP open-collector outputs, 30 VDC, 50 mA max. (residual voltage: 1 V max. for load current 10 mA max., 2 V max. for load current above 10 mA)
Laser OFF input, zero reset input, timing input, reset input, bank input		ON: Short-circuited with 0-V terminal or 1.2 V or less OFF: Open (leakage current: 0.1 mA max.)	ON: Supply voltage short-circuited or supply voltage within -1.2 V OFF: Open (leakage current: 0.1 mA max.)
Functions		Smart tuning, scaling, sample hold, peak hold, bottom hold, peak-to-peak hold, self-peak hold, self-bottom hold, average hold, zero reset, On-delay timer, OFF-delay timer, keep/clamp switch, (A-B) calculations *3, thickness calculation *3, mutual interference prevention *3, laser deterioration detection, bank function (4 banks), differential function	
Indications		Judgement indicators: HIGH (orange), PASS (green), LOW (orange), 11-segment main display (red), 11-segment sub-display (orange), laser ON (green), zero reset (green), enable (green), menu (green), HIGH threshold (orange), LOW threshold (orange)	
Power supply voltage		10 to 30 VDC, including 10% ripple (p-p)	
Power consumption		3,000 mW max. (at 24 VDC: 125 mA max., at 12 VDC: 250 mA max.)	
Ambient temperature		Operating: 0 to 50 °C, Storage: -15 to 70 °C (with no icing or condensation)	
Ambient humidity		Operating and storage: 35% to 85% (with no condensation)	
Dielectric strength		1,000 VAC, 50/60 Hz for 1 min.	
Vibration resistance (destruction)		10 to 150 Hz, 0.7-mm double amplitude, 80 min. each in X, Y, and Z directions	
Shock resistance (destruction)		300 m/s ² 3 times each in six directions (up/down, left/right, forward/backward)	
Degree of protection		IEC60529, IP40	
Connection method		Prewired (standard cable length: 2 m)	
Weight (packed state)		Approx. 200 g (main unit only: Approx. 135 g)	
Materials		Case: PBT (polybutylene terephthalate), Cover: Polycarbonate, Display: Methacrylic resin, Button: Polyacetal, Cable: PVC	
Accessories		Instruction sheet	

*1. In the case of Omron's standard target object (white ceramic)

*2. Select current output (4 to 20 mA) and voltage output (\pm 5V or 1 to 5V) by MENU mode.

*3. Calculating unit (ZX2-CAL) is necessary. Calculations are possible for up to two amplifier units. Mutual interference prevention is possible for up to five amplifier units.

Calculating Unit

Item	Model	ZX2-CAL
Applicable Amplifier Units		ZX2-LDA11, ZX2-LDA41
Current consumption		12 mA max. (supplied from the Smart Sensor Amplifier Unit)
Ambient temperature		Operating: 0 to +50°C, storage: -15 to +70°C (with no icing or condensation)
Ambient humidity		Operating and storage: 35% to 85% (with no condensation)
Connection method		Connector
Dielectric strength		1,000 VAC, 50/60 Hz for 1 minute
Vibration resistance (destruction)		10 to 150 Hz, 0.7-mm double amplitude, 80 minutes, each in X, Y, and Z directions
Shock resistance (destruction)		300 m/s ² 3 times each in six directions (up/down, left/right, forward/backward)
Materials		Case: ABS, Display: Methacrylic resin
Weight (packed state)		Approx. 50g (Calculating Unit only: Approx. 15g)
Accessories		Instruction sheet

ZX2-series Communications Interface Unit

Item	Model	ZX2-SF11
Power supply voltage		10 to 30 V DC \pm 10% (including 10% ripple (p-p)) (Supplied from Sensor Amplifier.)
Power consumption		720 mW max. (at 24 V: 30 mA max., at 12 V: 60 mA max.) (Not including Sensor Amplifier current consumption or output current)
Applicable Amplifier Units		ZX2-LDA□□ (Production after November 2013)
Applicable Amplifier Unit versions		Sensor Amplifier Unit version: V1.330 or higher (The Sensor Amplifier version is shown on the sub-digital display when the power of the Sensor Amplifier is turned ON.)
Max. No. of Amplifier Units		5
Communications functions	Port	RS-232C (9-pin, D-Sub connector)
	Communications method	Full duplex
	Synchronization method	Start/stop synchronization
	Transmission code	ASCII
	Baud rate	38,400 (at shipping)/9,600 bps switchable
	Data bit length	8 bits
	Parity check	None
	Stop bit length	1 bit
Data delimiter	Receiving	CR or CR + LF is automatically recognized.
	Sending	CR + LF fixed
Indicators		Power supply: green, Sensor communications: green, Sensor communications error: red, External terminal communications: green, External terminal communications error: red
Protective circuits		Power supply reverse polarity protection
Ambient temperature		Operating: 0 to 50°C, storage: -15 to 60°C (with no icing or condensation)
Ambient humidity		Operating and storage: 35% to 85% (with no condensation)
Insulation resistance		20 M Ω min. (at 500 VDC)
Dielectric strength		1,000 VAC, 50/60 Hz for 1 min, Leakage current: 10 mA max.
Materials		Case: PBT (polybutylene terephthalate), Cover: Polycarbonate
Accessories		Instruction sheet, 2 clamps

Engineering Data (Reference Value)

Angle Characteristic

The angle characteristic is a plot of the inclination of the sensing object in the measurement range and the maximum value of the error to analog output.

Note: SUS304 = Stainless steel SUS304

ZX2-LD50

Side-to-side Inclination

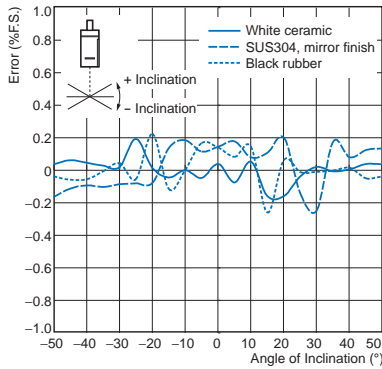

Front-to-back Inclination

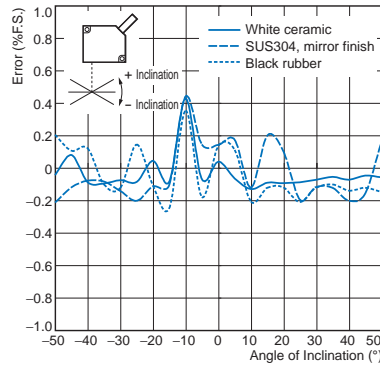

ZX2-LD50L

Side-to-side Inclination

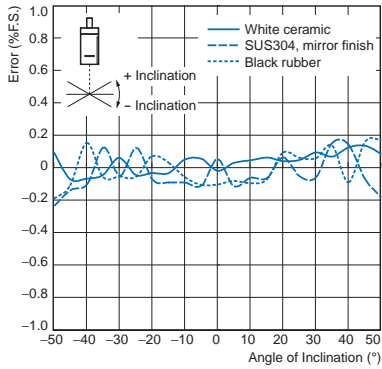

Front-to-back Inclination

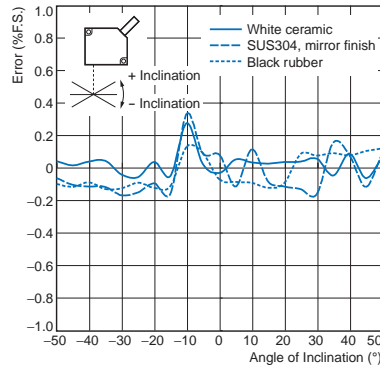

ZX2-LD100

Side-to-side Inclination

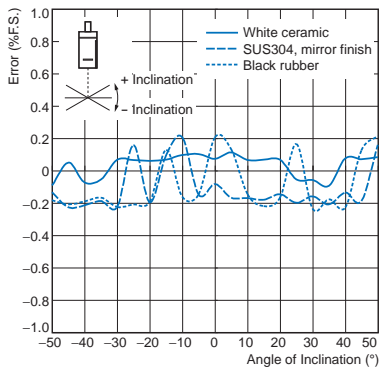

Front-to-back Inclination

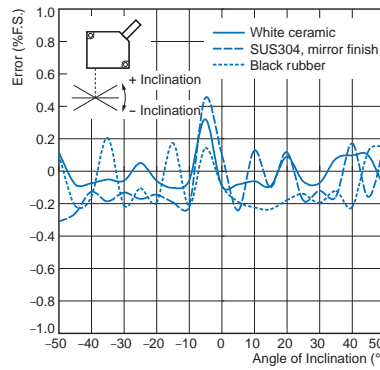

ZX2-LD100L

Side-to-side Inclination

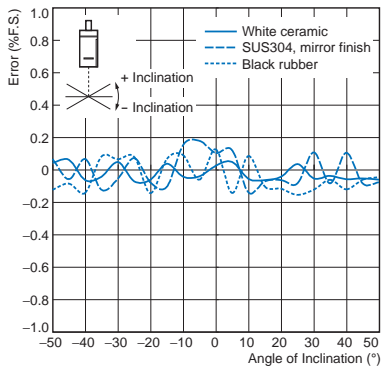

Front-to-back Inclination

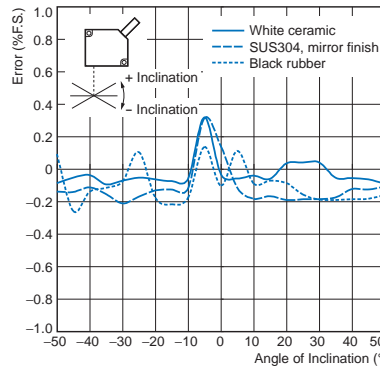

Linearity Characteristic for Different Materials

ZX2-LD50

0° Inclination

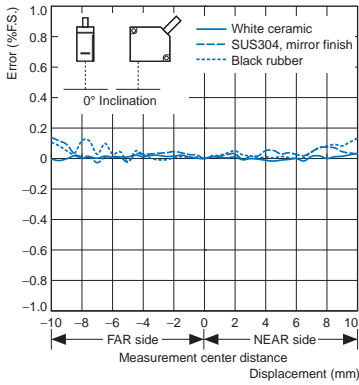

-50° Inclination Front-to-back

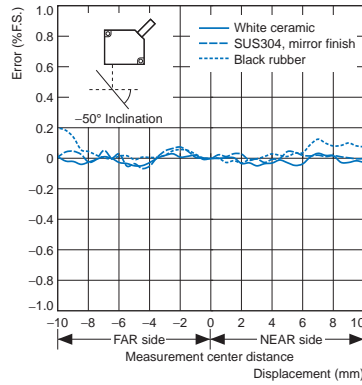

+50° Inclination

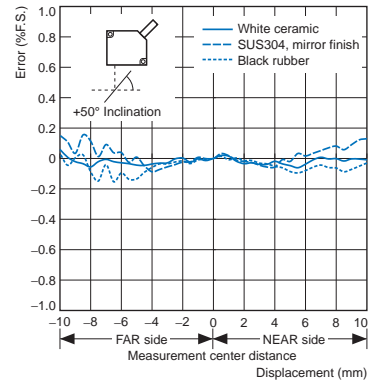

ZX2-LD50L

0° Inclination

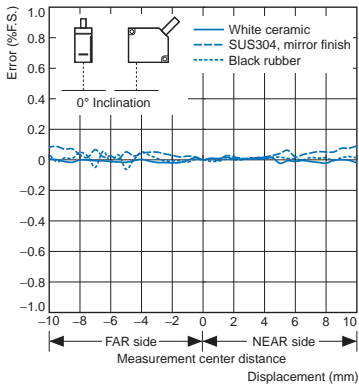

-50° Inclination Front-to-back

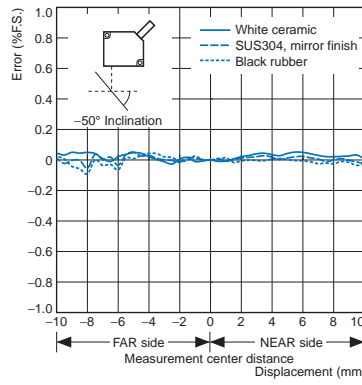

+50° Inclination

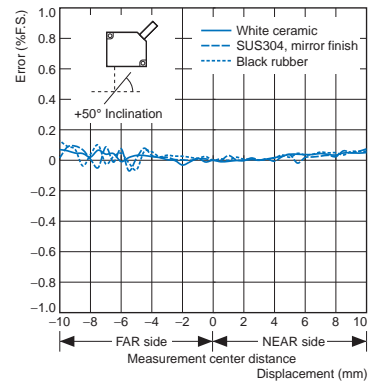

ZX2-LD100

0° Inclination

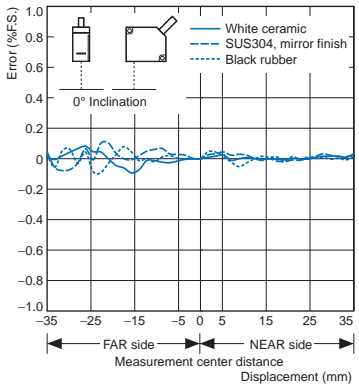

-50° Inclination Front-to-back

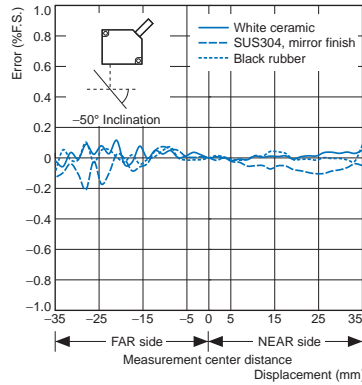

+50° Inclination

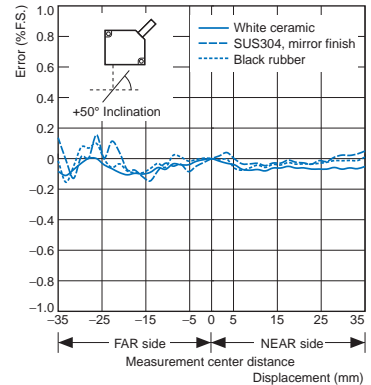

ZX2-LD100L

0° Inclination

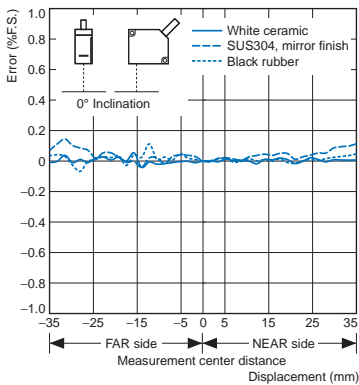

-50° Inclination Front-to-back

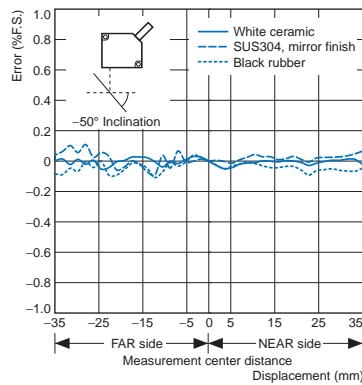

+50° Inclination

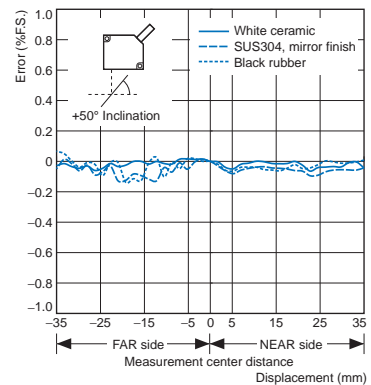

Note: The x-axis displacement indicates the measurement distance displayed by the amplifier unit. The measurement distance displayed by the amplifier unit takes the measurement center distance as 0, and the NEAR and FAR sides from the sensor are displayed by + and -, respectively.

Angle Characteristic

ZX2-LD50V

Side-to-side Inclination for Flat Mirror

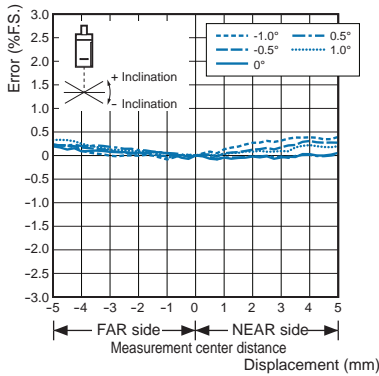

Front-to-back Inclination for Flat Mirror

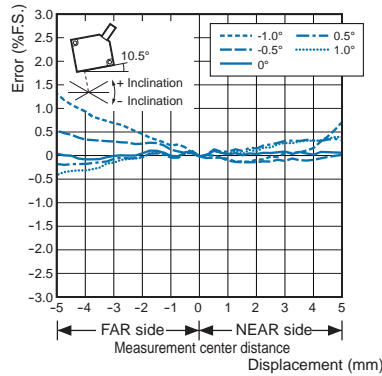

Side-to-side Inclination for Silicon Wafer

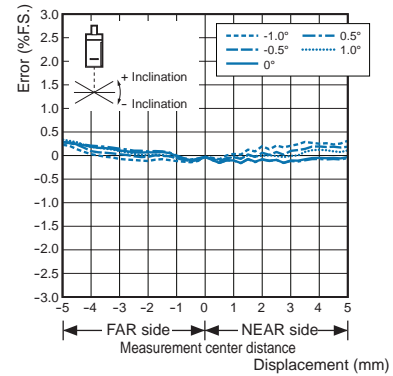

Front-to-back Inclination for Silicon Wafer

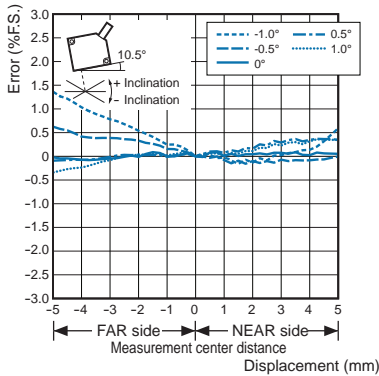

Side-to-side Inclination for Glass

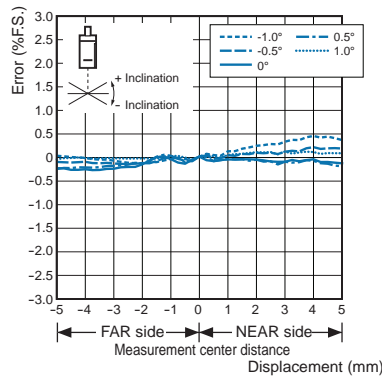

Front-to-back Inclination for Glass

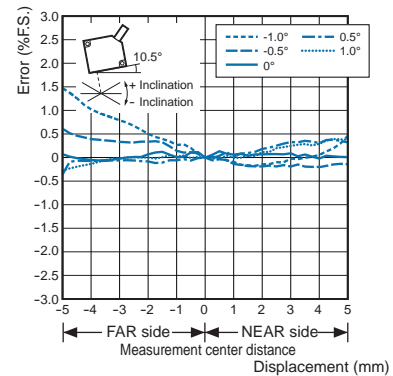

Linearity Characteristic for Different Materials

ZX2-LD50V

0° Inclination

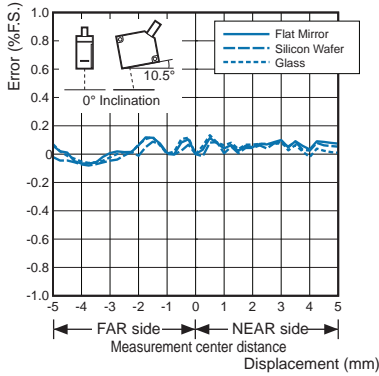

Note: The x-axis displacement indicates the measurement distance displayed by the amplifier unit. The measurement distance displayed by the amplifier unit takes the measurement center distance as 0, and the NEAR and FAR sides from the sensor are displayed by + and -, respectively.

Beam Size

Spot Beams

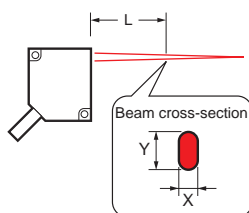

ZX2-LD50

L *	+10 mm	0 mm	-4 mm	-10 mm
X	Approx. 600 μm	Approx. 160 μm	Approx. 40 μm	Approx. 220 μm
Y	Approx. 350 μm	Approx. 90 μm	Approx. 60 μm	Approx. 130 μm

ZX2-LD100

L *	+35 mm	0 mm	-20 mm	-35 mm
X	Approx. 1.1 mm	Approx. 400 μm	Approx. 70 μm	Approx. 250 μm
Y	Approx. 550 μm	Approx. 190 μm	Approx. 110 μm	Approx. 150 μm

Line Beams

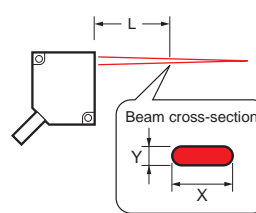

ZX2-LD50L

L *	+10 mm	0 mm	-4 mm	-10 mm
X	Approx. 2.6 mm	Approx. 2.6 mm	Approx. 2.6 mm	Approx. 2.6 mm
Y	Approx. 350 μm	Approx. 90 μm	Approx. 60 μm	Approx. 130 μm

ZX2-LD100L

L *	+35 mm	0 mm	-20 mm	-35 mm
X	Approx. 2.1 mm	Approx. 2.5 mm	Approx. 2.7 mm	Approx. 2.9 mm
Y	Approx. 550 μm	Approx. 190 μm	Approx. 110 μm	Approx. 150 μm

* Measurement distance displayed by the amplifier unit. The measurement distance displayed by the amplifier unit takes the measurement center distance as 0, and the NEAR and FAR sides from the sensor are displayed by + and -, respectively.

I/O Circuit Diagrams

NPN Amplifier Unit (ZX2-LDA11)

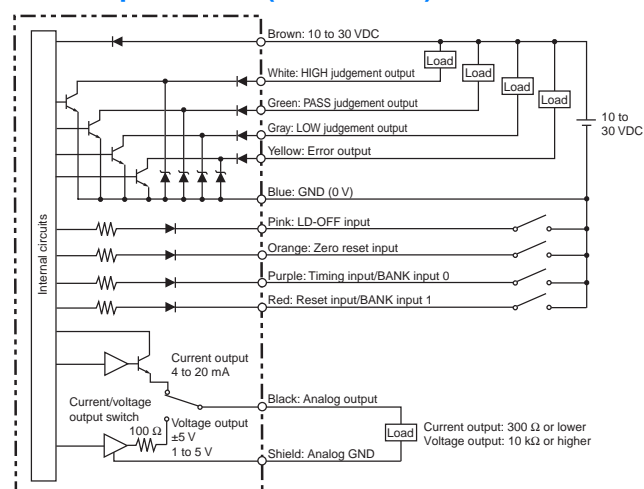

PNP Amplifier Unit (ZX2-LDA41)

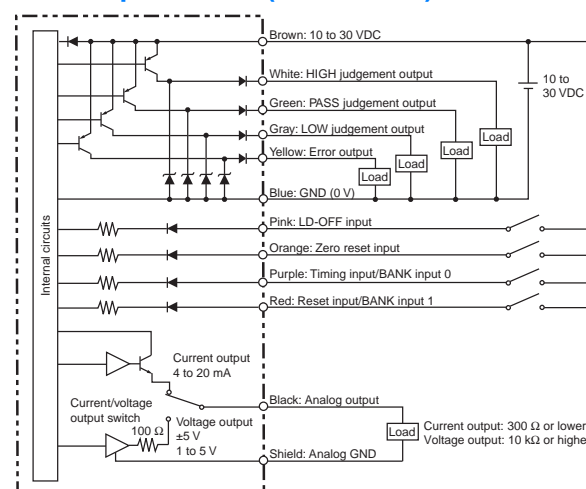

Wiring

Amplifier Units

ZX2-LDA11/ZX2-LDA41

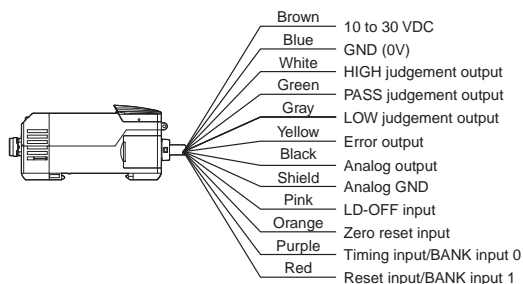

- Note:**
1. Use a separate stabilized power supply for the Amplifier Unit, particularly when high resolution is required.
 2. Wire the Unit correctly. Incorrect wiring may result in damage to the Unit. (Do not allow wiring, particularly the Analog output, to come into contact with other wires.)
 3. Use the 0-V ground (blue) for the power supply and use the Analog ground (shield) for Analog output. Each of these grounds must be used for the designed purpose. When not using the Analog output, connect the Analog ground (shield) to the 0-V ground (blue).

Safety Precautions

For details, refer to common precautions, warranty, limitation of liability, and other related information.



WARNING

This product is not designed or rated for ensuring safety of persons.
Do not use it for such purposes.



Precautions for Correct Use and Other Details
Refer to the "Smart Sensors Laser Displacement Sensors CMOS Type ZX2 Series User's Manual" (Cat. No. Z310).

Dimensions

(Unit: mm)
Tolerance class IT16 applies to dimensions in this data sheet unless otherwise specified.

Units

Sensor Heads

ZX2-LD50
ZX2-LD50L
ZX2-LD100
ZX2-LD100L
ZX2-LD50V

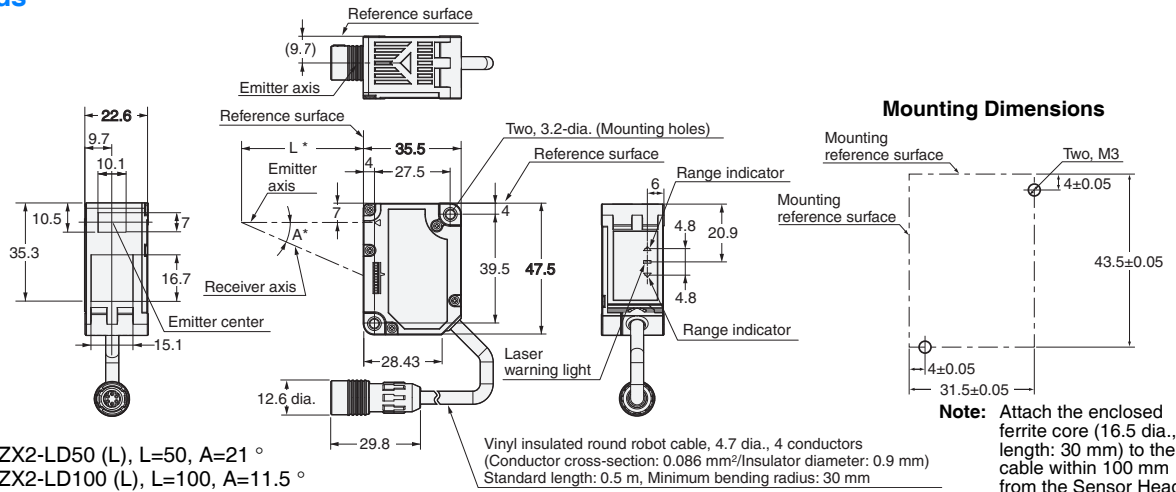

* In the case of ZX2-LD50 (L), L=50, A=21 °
In the case of ZX2-LD100 (L), L=100, A=11.5 °

Amplifier Units

ZX2-LDA11
ZX2-LDA41

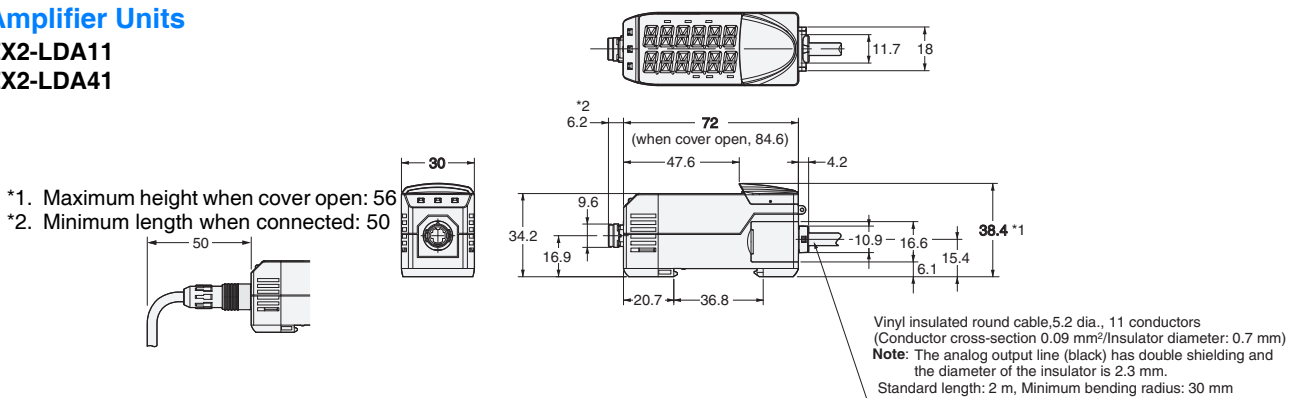

Accessories (sold separately)

Calculating Unit

ZX2-CAL

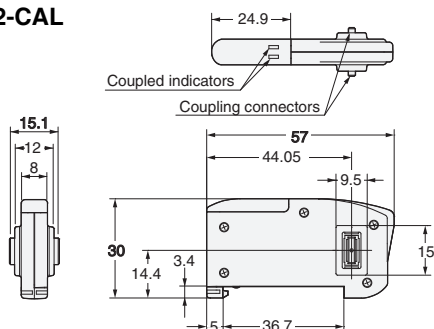

Sensor Head Extension Cables

ZX2-XC1R
 ZX2-XC4R
 ZX2-XC9R
 ZX2-XC20R

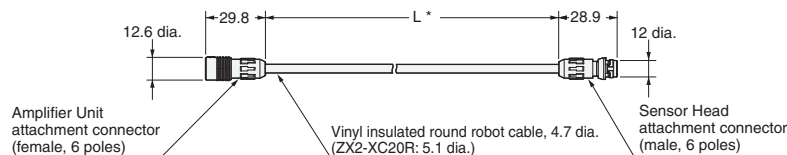

* Length L is as follows.
 ZX2-XC1R: 1 m, ZX2-XC4R: 4 m, ZX2-XC9R: 9 m, ZX2-XC20R: 20 m
 Minimum bending radius: 30 mm

Note: Attach the enclosed ferrite cores (16.5 dia., length: 30 mm) within 100 mm of each end of the extension cable.

ZX2-series Communications Interface Unit

ZX2-SF11

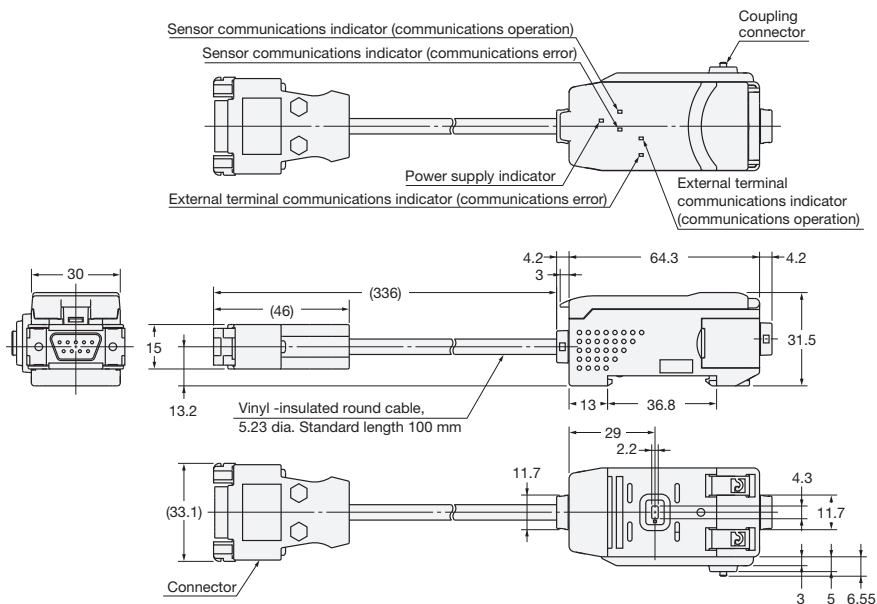

Mounting Bracket

E39-L178

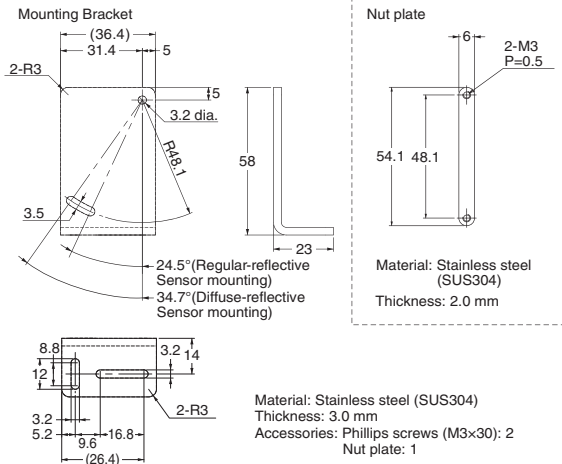

Mounting Bracket

E39-L179

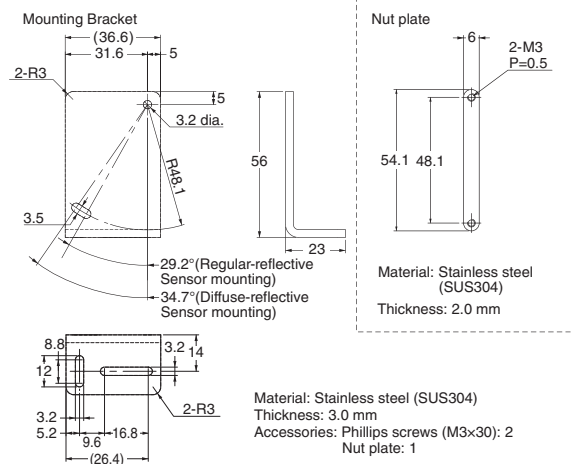

*Use this Mounting Bracket when installing the ZX2-LD100 (L) as a normal Diffuse-reflective or Regular-reflective Sensor Head.

Installation Method for Regular-reflective Sensor Head Using a E39-L178 Mounting Bracket:

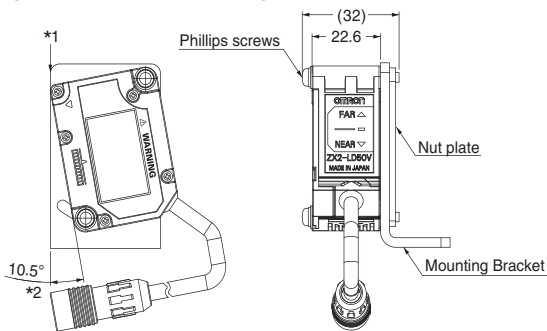

Note: When securing the Sensor Head in the Mounting Bracket, insert the screws into the side of the Sensor Head where the warning label is located and secure the Sensor Head into place.

- *1. The measurement distance reference position is the end of the Mounting Bracket.
- *2. For the Regular-reflective Sensor Heads, rotate the Sensor Head counterclockwise, secure it in place, and then perform any necessary fine adjustments.

Installation Method for Regular-reflective Sensor Heads (Installing a Diffuse-reflective Sensor Head as a Regular-reflective Sensor Head)

Using a E39-L179 Mounting Bracket:

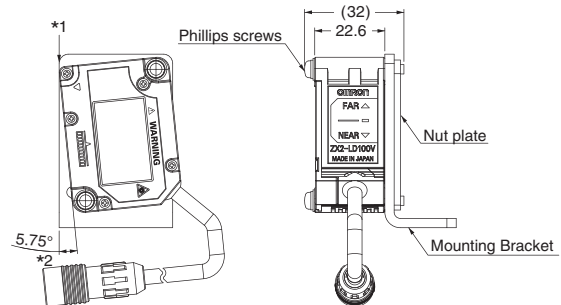

Note: When securing the Sensor Head in the Mounting Bracket, insert the screws into the side of the Sensor Head where the warning label is located and secure the Sensor Head into place.

- *1. The measurement distance reference position is the end of the Mounting Bracket.
- *2. For the Installing a Diffuse-reflective Sensor as a Regular-reflective Sensor, rotate the Sensor Head counterclockwise, secure it in place, and then perform any necessary fine adjustments.

Not Using a Mounting Bracket:

Tilt the Sensor Head towards the workpiece as shown below.

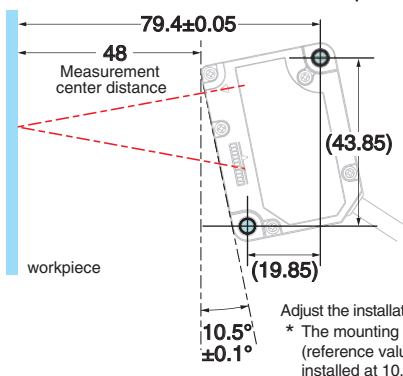

Adjust the installation so that the angle is 10.5° ±0.1°.
 * The mounting hole dimensions in parentheses (reference values) are for when the Sensor is installed at 10.5°.

Installation Method for Diffuse-reflective Sensor Heads

Using a E39-L178, E39-L179 Mounting Bracket:

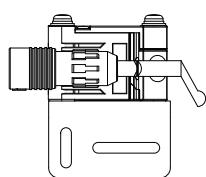
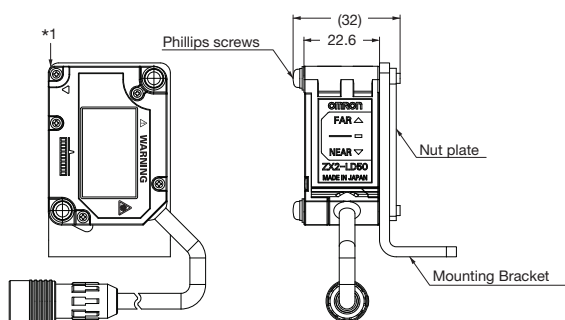

*1 The measurement distance reference position is the Sensor's sensing surface.

Note: When securing the Sensor Head in the Mounting Bracket, insert the screws into the side of the Sensor Head where the warning label is located and secure the Sensor Head into place.

Not Using a Mounting Bracket:

Mount the Sensor Head in relation to the workpiece as shown below.

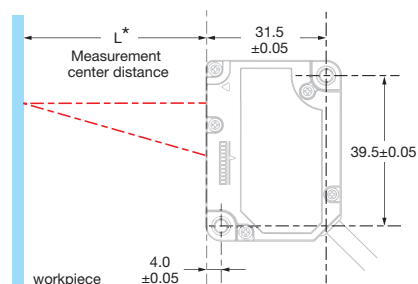

* ZX2-LD50 (L): 50
ZX2-LD100 (L): 100

Terms and Conditions Agreement

Read and understand this catalog.

Please read and understand this catalog before purchasing the products. Please consult your OMRON representative if you have any questions or comments.

Warranties.

(a) Exclusive Warranty. Omron's exclusive warranty is that the Products will be free from defects in materials and workmanship for a period of twelve months from the date of sale by Omron (or such other period expressed in writing by Omron). Omron disclaims all other warranties, express or implied.

(b) Limitations. OMRON MAKES NO WARRANTY OR REPRESENTATION, EXPRESS OR IMPLIED, ABOUT NON-INFRINGEMENT, MERCHANTABILITY OR FITNESS FOR A PARTICULAR PURPOSE OF THE PRODUCTS. BUYER ACKNOWLEDGES THAT IT ALONE HAS DETERMINED THAT THE PRODUCTS WILL SUITABLY MEET THE REQUIREMENTS OF THEIR INTENDED USE.

Omron further disclaims all warranties and responsibility of any type for claims or expenses based on infringement by the Products or otherwise of any intellectual property right. (c) Buyer Remedy. Omron's sole obligation hereunder shall be, at Omron's election, to (i) replace (in the form originally shipped with Buyer responsible for labor charges for removal or replacement thereof) the non-complying Product, (ii) repair the non-complying Product, or (iii) repay or credit Buyer an amount equal to the purchase price of the non-complying Product; provided that in no event shall Omron be responsible for warranty, repair, indemnity or any other claims or expenses regarding the Products unless Omron's analysis confirms that the Products were properly handled, stored, installed and maintained and not subject to contamination, abuse, misuse or inappropriate modification. Return of any Products by Buyer must be approved in writing by Omron before shipment. Omron Companies shall not be liable for the suitability or unsuitability or the results from the use of Products in combination with any electrical or electronic components, circuits, system assemblies or any other materials or substances or environments. Any advice, recommendations or information given orally or in writing, are not to be construed as an amendment or addition to the above warranty.

See <http://www.omron.com/global/> or contact your Omron representative for published information.

Limitation on Liability: Etc.

OMRON COMPANIES SHALL NOT BE LIABLE FOR SPECIAL, INDIRECT, INCIDENTAL, OR CONSEQUENTIAL DAMAGES, LOSS OF PROFITS OR PRODUCTION OR COMMERCIAL LOSS IN ANY WAY CONNECTED WITH THE PRODUCTS, WHETHER SUCH CLAIM IS BASED IN CONTRACT, WARRANTY, NEGLIGENCE OR STRICT LIABILITY.

Further, in no event shall liability of Omron Companies exceed the individual price of the Product on which liability is asserted.

Suitability of Use.

Omron Companies shall not be responsible for conformity with any standards, codes or regulations which apply to the combination of the Product in the Buyer's application or use of the Product. At Buyer's request, Omron will provide applicable third party certification documents identifying ratings and limitations of use which apply to the Product. This information by itself is not sufficient for a complete determination of the suitability of the Product in combination with the end product, machine, system, or other application or use. Buyer shall be solely responsible for determining appropriateness of the particular Product with respect to Buyer's application, product or system. Buyer shall take application responsibility in all cases.

NEVER USE THE PRODUCT FOR AN APPLICATION INVOLVING SERIOUS RISK TO LIFE OR PROPERTY OR IN LARGE QUANTITIES WITHOUT ENSURING THAT THE SYSTEM AS A WHOLE HAS BEEN DESIGNED TO ADDRESS THE RISKS, AND THAT THE OMRON PRODUCT(S) IS PROPERLY RATED AND INSTALLED FOR THE INTENDED USE WITHIN THE OVERALL EQUIPMENT OR SYSTEM.

Programmable Products.

Omron Companies shall not be responsible for the user's programming of a programmable Product, or any consequence thereof.

Performance Data.

Data presented in Omron Company websites, catalogs and other materials is provided as a guide for the user in determining suitability and does not constitute a warranty. It may represent the result of Omron's test conditions, and the user must correlate it to actual application requirements. Actual performance is subject to the Omron's Warranty and Limitations of Liability.

Change in Specifications.

Product specifications and accessories may be changed at any time based on improvements and other reasons. It is our practice to change part numbers when published ratings or features are changed, or when significant construction changes are made. However, some specifications of the Product may be changed without any notice. When in doubt, special part numbers may be assigned to fix or establish key specifications for your application. Please consult with your Omron's representative at any time to confirm actual specifications of purchased Product.

Errors and Omissions.

Information presented by Omron Companies has been checked and is believed to be accurate; however, no responsibility is assumed for clerical, typographical or proofreading errors or omissions.