

IoT Flow Sensors

# E8FC-25D/25T/25

## Detect Signs of Abnormalities in Cooling Water by Simultaneous Measurement of “Flow Rate + Temperature”

- Multi-sensing of “Flow rate + temperature” for preventing a sudden stops or manufacturing defects.
- Various lineup of replacement adapters to enable easy replacement of your current pressure gauges and flow meters.
- Analog current output function in addition to the IO-Link communications function that can perform self-diagnosis of abnormalities in the sensor itself.



 Refer to *Safety Precautions* on page 10.

For the most recent information on models that have been certified for safety standards, refer to your OMRON website.

## Ordering Information

### Sensors *[Refer to Dimensions on page 13.]*

Appearance	Applicable fluid *	Control output	Communication method	IO-Link baud rate	Model
	Liquid	PNP	IO-Link Analog	COM2 (38.4 kbps)	<b>E8FC-25D</b>
				COM3 (230.4 kbps)	<b>E8FC-25T</b>
	NPN	Analog	---	<b>E8FC-25</b>	





**Note:** Please contact your OMRON sales representative regarding the IO-Link setup file (IODD file).

\* The applicable fluid is a liquid that does not erode the wetted part materials (for example, water or a fluid whose conductivity is equivalent to that of water).

# E8FC-25D/25T/25

## Adapters [Refer to Dimensions on page 13.]

It must be selected from the adapters below.

Appearance	Applicable diameter *		Thread type	Materials	Model
	Nominal diameter A	Nominal diameter B			
	10 A	3/8"	R (taper thread)	SUS304	E8FC-YA-R10A
			NPT (taper thread)		E8FC-YA-N10A
	15 A	1/2"	R (taper thread)		E8FC-YA-R15A
			NPT (taper thread)		E8FC-YA-N15A
	20 A	3/4"	R (taper thread)		E8FC-YA-R20A
			NPT (taper thread)		E8FC-YA-N20A
	25 A	1"	R (taper thread)		E8FC-YA-R25A
			NPT (taper thread)		E8FC-YA-N25A

\* It is recommended that the piping fitting diameters be the same on both the piping side and the sensor mounting side.



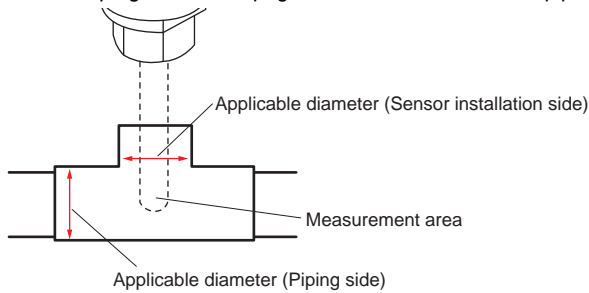

Because the sensor is designed so that the measurement area is in the center of the piping, correct measurement may not be possible with different diameter fittings.

Refer to *Piping Method* on page 12 for the recommended pipe joint.

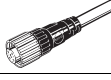

## Cables (Sensor I/O Connectors)

A Cable is not provided with the Sensor. It must be ordered separately.

Type	Appearance	Cable	Model
Socket on one cable end		2 m	XS5F-D421-D80-F
		5 m	XS5F-D421-G80-F
		2 m	XS5F-D422-D80-F
		5 m	XS5F-D422-G80-F
Socket and plug on cable ends *		2 m	XS5W-D421-D81-F
		5 m	XS5W-D421-G81-F
		2 m	XS5W-D422-D81-F
		5 m	XS5W-D422-G81-F

**Note:** Refer to *Sensor I/O Connectors/Sensor Controllers* on OMRON website for details.

\* Straight type/L-shape type combinations are also available.

## O-ring (for replacement) [Refer to Dimensions on page 14.]

Appearance	Type	Model
	For E8FC-25□	E8FC-YL-1

## Ratings and Specifications

### Sensors

Model	PNP (COM2)	E8FC-25D			
	PNP (COM3)	E8FC-25T			
	NPN	E8FC-25			
Applicable diameter	Nominal diameter B	3/8"	1/2"	3/4"	1"
	Nominal diameter A	10 A	15 A	20 A	25 A
Applicable fluid	The fluid must not corrode the material of the wetted part (for example, water or a fluid whose conductivity is equivalent to that of water).				
Permissible pressure *1	10 MPa				
Flow rate monitoring *2	Rated flow rate range	0.6 to 14 l/min	1 to 30 l/min	1.5 to 60 l/min	2 to 100 l/min
		Inner diameter setting (10 A, 15 A, 20 A, 25 A)			
	Display range	0 to 16 l/min	0 to 33 l/min	0 to 66 l/min	0 to 110 l/min
	Zero cutting flow rate *3	0.6 l/min	1 l/min	1.5 l/min	2 l/min
	Display resolution (l/min)	0.1/1 (Selectable)			
	Flow rate monitoring response time	Control output: 1.0, 2.5, 5, 10, 30, 60 s			
	Flow rate monitoring precision *4	± (7.0% of measured value + 2.0% F.S.) or less			
	Flow rate repeatability / F.S. (prescribed for each response time)	1 s: ±3.5%, 2.5 s: ±2.5%, 5 s: ±1.6%, 10 s: ±1%, 30 s: ±0.8%, 60 s: ±0.6%			
	Ambient temperature characteristics *5	±1.0% F.S./10°C			
Hysteresis	Variable				
Temperature monitoring *6	Temperature monitoring rated range *7	0 to 85°C			
	Temperature monitoring precision	±2.5°C			
	Temperature repeatability	±0.5°C			
Control output judgment (selectable)	Standard mode	Judge if the measured value is the threshold value or more (or less).			
	Window mode	Judge if the measured value is within the upper and lower limits.			
Display method	Numerical value indication: 4-digit 7-segment white LED with inverting function Status indicators: The content of indication is selectable from green, orange, red, and OFF. Output indicator: OUT1 operation (orange), OUT2 operation (orange) Unit indicator: l/min (White), % (White), °C (White), ST (White) Communication indicator: Lighting when communications are in progress (green)				
Delay setting	1 to 9999 ms (Select a function from invalid, ON delay, OFF delay, and one-shot.)				
Connection method	M12, 4-pole connector type				
Output ch1 (selectable)	Control output	Flow rate control output (N.O./N.C.) E8FC-25D/-25T: PNP E8FC-25: NPN 30 VDC or less, Class 2, 100 mA max., residual voltage 1 V or less			
	Pulse output	1/ 10/ 100/1000 l			
Output ch2 (selectable)	Control output	Flow rate control output (N.O./N.C.) / temperature control output (N.O./N.C.) E8FC-25D/-25T: PNP E8FC-25: NPN 30 VDC or less, Class 2, 100 mA max. residual voltage 1 V or less			
	Analog current output *8	Flow rate analog output /temperature analog output Current output 4 to 20 mA (maximum load resistance 350Ω or less) (Display value ± 2% of F.S.)			
	Pulse output	1/ 10/ 100/1000 l			
	External input	Smart tuning, One-point tuning, short-circuit current 1.5 mA or less, input time 20 ms or more			

# E8FC-25D/25T/25

Model	PNP (COM2)	E8FC-25D
	PNP (COM3)	E8FC-25T
	NPN	E8FC-25
IO-Link	IO-Link specification	Ver 1.1
	Baud rate	E8FC-25D: COM2 (38.4kbps) E8FC-25T: COM3 (230.4Kbps)
	Data length	PD Size: 6 byte OD Size: 1 byte (M-sequence type: TYPE_2_V)
	Minimum cycle time	E8FC-25D (COM2): 3.2 ms E8FC-25T(COM3): 2.0 ms
Power supply	Power supply voltage	15 to 30 VDC (including 10% ripple (p-p)), Class 2
	Power consumption	2,880 mW or less (When power supply voltage is 30 V, current consumption must be 96 mA or less. When power supply voltage is 15 V, current consumption must be 192 mA or less.)
Protection circuit		Power supply reverse connection protection, output short-circuit protection, and output reverse connection protection
Environment resistance	Ambient temperature range	-20 to 70°C in operation and storage, respectively (no condensation)
	Applicable fluid temperature	0 to 85°C (no icing on the pipe surface)
	Ambient humidity range	35 to 85%RH in operation and storage, respectively (no condensation)
	Withstand voltage	500 VAC 50/60 Hz 1min
	Vibration resistance (destruction)	10 to 2000 Hz, double amplitude 1.5 mm, 2 hours in X/Y/Z direction each
	Shock resistance (destruction)	500 m/s <sup>2</sup> , three times in X/Y/Z direction each
	Protective structure	IP67
	Pollution degree	3
	Altitude	2,000 m or less
	Installation place	Indoor
Materials	Wetted part	Detecting unit: SUS304L, O-ring: FKM
	Other than wetted part	Head: PPSU, display unit: PES, button: PBT, chassis: SUS304L, nut: SUS304
Weight	Approx. 190 g	
Accessories	<ul style="list-style-type: none"> <li>• Ferrite core x 1 (TDK's Model ZCAT1 730-0730A)</li> <li>• User's manual (Japanese, English, and Chinese), one each</li> <li>• Compliance sheet</li> <li>• Index list</li> </ul>	

\*1. Even instantaneous pressure fluctuation such as water hammer must be within the permissible pressure.

\*2. Flow monitoring performance is defined by the values measured under the following conditions using OMRON's factory adjustment equipment.

- OMRON's factory adjustment equipment: Pipe diameter 20A, straight pipe length 900 mm or more, recommended pipe joint (KITZ's PTZ-20A), dedicated adapter (E8FC-YA-R20A)
- The long side of the chassis holding unit is installed toward the upstream side of the piping. Refer to *Piping method* on page 12.
- Measured normal temperature water (approx. 23°C) under normal temperature environment (approx. 23°C)

Since each performance depends on the water level of the piping, there is a possibility that the measured value may deviate depending on the condition that the inside of the piping including the pipe joint is not filled with water, fluid pulsation, and clogging of the piping.

\*3. Cutting to zero is the function outputting the flow rate less than the minimum rated flow rate as zero.

\*4. The accuracy of flow rate monitoring when the pipe diameter is 20A. For piping sizes 10A, 15A and 25A, refer to *Characteristic Data* on page 5 in the catalog before use.

\*5. The ambient temperature characteristics are defined by the values measured under the following conditions.

- Pipe diameter 20A, Straight pipe length: 900 mm or more, recommended pipe joint (KITZ's PTZ-20A), dedicated adapter (E8FC-YA-R20A)
- The long side of the chassis holding unit is installed toward the upstream side of the piping. Refer to *Piping method* on page 12.
- Water at room temperature (approx. 23°C) was measured at a flow rate of 30 l/min.

\*6. The performance of temperature monitoring is specified by the values measured under the following conditions.

- Pipe diameter 20 A, recommended pipe joint (KITZ's PTZ-20A), dedicated adapter (E8FC-YA-R20A)
- The long side of the chassis holding unit is installed toward the upstream side of the piping. Refer to *Piping method* on page 12.
- In a normal temperature environment (approx. 23°C)

\*7. If the pipe temperature exceeds 70°C, do not contact any cables with the pipe.

\*8. Do not connect CH 2 (pin 2) with the IO-Link master unit in analog current output mode. Otherwise, the unit might fail.

## Characteristic Data

The graphs below show the flow rate precision characteristics that are measured using our test equipment under the following conditions. The values are provided for reference.

- Recommended pipe joint (PTZ-20A by KITZ) , dedicated adapter (E8FC-YA-R20A)
- The long side of the sensor housing holder is installed toward the upstream side of the piping. Refer to *Piping method* on page 12.
- Measured normal temperature water (approx. 23°C) under normal temperature environment (approx. 23°C)

### Flow rate precision characteristics for pipes

Precision characteristics when straight pipe length is 40D (D: inner diameter of pipe) or more

#### Pipe diameter: 10 A

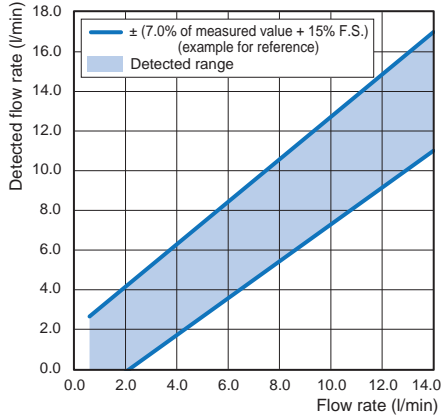

#### Pipe diameter: 15 A

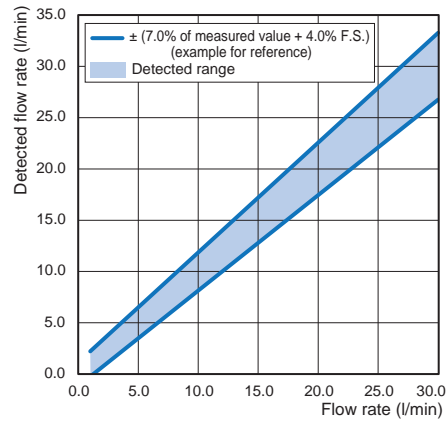

#### Pipe diameter: 20 A

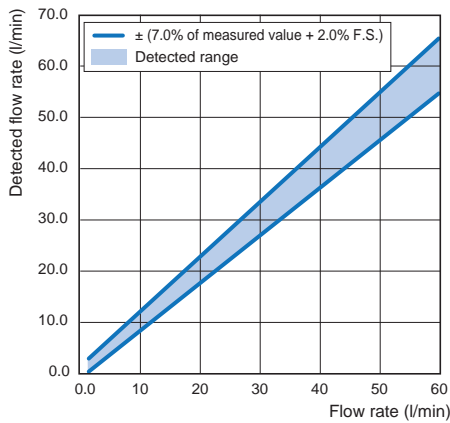

#### Pipe diameter: 25 A

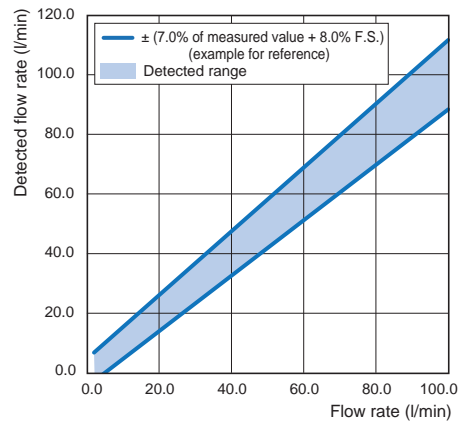

# E8FC-25D/25T/25

## I/O Circuit Diagrams

### PNP output

Model	Output mode	I/O Circuit Diagrams*		
		External input mode	Control output mode	Analog current output mode
E8FC-25D E8FC-25T	Standard I/O mode (SIO mode)			
	IO-Link mode			

\* Pin 2 input/output can be switched with either the operation buttons or the IO-Link communication command "Pin 2 switching mode selection".

### NPN output

Model	Output mode	I/O Circuit Diagrams*		
		External input mode	Control output mode	Analog current output mode
E8FC-25	-			

\* Pin 2 input/output can be switched with the operation buttons.

### Connector Pin Arrangement

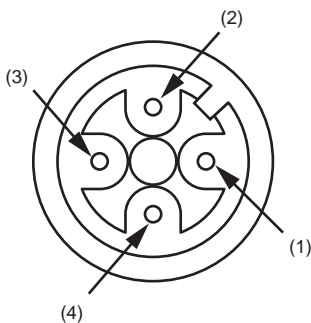

Applicable connector code: XS5F / XS5W series

Applicable IO-Link master unit: NX/GX series

Pin No.	E8FC-25D E8FC-25T		E8FC-25
	Standard I/O mode	IO-Link mode	
(1)	+V	+V	+V
(2)	EXTIN/Analog/OUT2 *	Analog/OUT2 *	EXTIN/Analog/OUT2 *
(3)	0 V	0 V	0 V
(4)	C/Q	C/Q	Q

EXTIN: External input  
Q: Control output  
C: IO-Link communications

\* Pin 2 input/output can be switched with either the operation buttons or the IO-Link communication command, "Pin 2 switching mode selection".

# Timing Charts

The PNP output is described below by using the flow rate control output of OUT1 as an example. The activity is the same even when temperature control output is selected in OUT2.

## PNP output

Model	Output mode	N.O./N.C. setting *1	Timing charts *2	
			Standard mode	Window mode
E8FC-25D E8FC-25T	Standard I/O mode (SIO mode)	N.O. *3		
		N.C.		
	IO-Link mode	N.O. *3		
		N.C.		

\*1. The N.O./N.C. setting can be changed by the operation buttons or IO-Link communications.

\*2. The timer function can be set individually for OUT1 and OUT2 by the operation buttons or IO-Link communications. (Selection of ON delay, OFF delay, or one-shot function, and selection of a timer time from 1 to 9999 ms)  
The delay timing of each function is same as the NPN output. Refer to the next page.

\*3. Factory default

NPN output

Model	N.O./N.C. setting *1	Timing charts *2	
		Standard mode	Window mode
E8FC-25	N.O. *3		
	N.C.		

\*1. The N.O./N.C. setting can be changed by the operation buttons.

\*2. The timer function can be set individually for OUT1 and OUT2 by the operation buttons.

(Selection of ON delay, OFF delay, or one-shot function, and selection of a timer time from 1 to 9999 ms)

ON delay		One-shot	
OFF delay			

\*3. Factory default



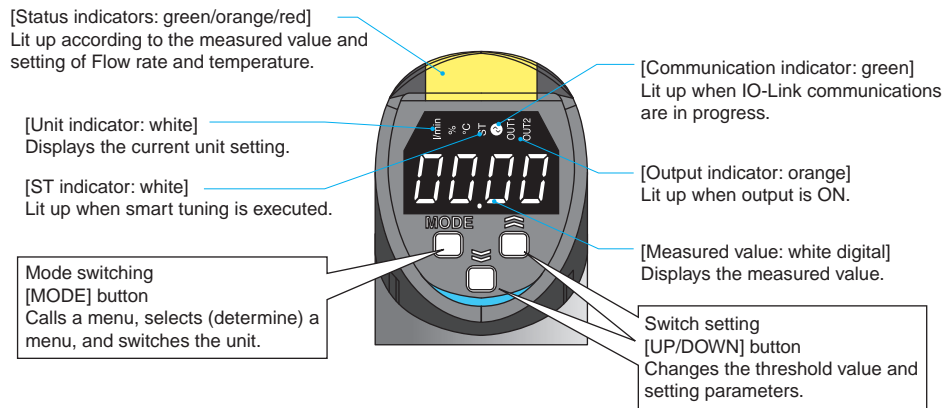

## Nomenclature







## Safety Precautions

Be sure to read the precautions for all models in the website at: <http://www.ia.omron.com/>.

### Warning Indications

 <b>Warning</b>	Indicates a potentially hazardous situation which, if not avoided, will result in minor or moderate injury, or may result in serious injury or death. Additionally, there may be significant property damage.
 <b>Caution</b>	Indicates a potentially hazardous situation which, if not avoided, may result in minor or moderate injury or in property damage.
<b>Precautions for Safe Use</b>	Supplementary comments on what to do or avoid doing, to use the product safely.
<b>Precaution for Correct Use</b>	Supplementary comments on what to do or avoid doing, to prevent failure to operate, malfunction or undesirable effect on product performance.

### Meaning of Product Safety Symbols

	<b>General Prohibition</b> Indicates the instructions of unspecified prohibited action.
	<b>General caution</b> Indicates unspecified general alert.
	<b>Caution, explosion</b> Indicates the possibility of explosion under specific conditions.
	<b>Caution, high temperature</b> Indicates the possibility of injuries by high temperature under specific conditions.
	<b>Caution, fire</b> Indicates the possibility of fires under specific conditions.

### **WARNING**

This product is not designed or rated for ensuring safety of persons either directly or indirectly. Do not use it for such purpose.



The specification of this product is not for beverage, food, or medical chemicals. Do not use this product for the device contacting beverage, food, or medical chemicals.



Do not use the product with voltage in excess of the rated voltage. Excess voltage may result in malfunction or fire.



This product is not assumed to be used in explosion-proof areas. Do not use the product in explosion proof areas.



Never use the product with an AC power supply. Otherwise, explosion may result.



The product might fail or be destroyed. Do not impress any pressure exceeding the rated value even instantaneously.



The product might fail or be damaged. Do not stand on the sensor, or add excessive load.



The fluid in the pipe might spout out. Tighten the prescribed O-ring to the pipe.



### **Caution**

The product might fail or be damaged. Piping, wiring, maintenance, and checkup must be done by operators with expertise.



The product might be damaged or fire. Do not short-circuit load.



The product might be damaged or fire. Be careful with polarity of the power supply to avoid incorrect wiring.



The user might get burned. The sensor surface temperature rises depending on the operating condition such as ambient temperature, power supply voltage, or fluid temperature. Be careful when operating or cleaning the product.



### Precautions for Safe Use

The following items are necessary for ensuring safety, so be sure to observe them.

- Do not use the product in the following installation areas.
  - Locations subject to direct sunlight
  - Locations subject to condensation due to high humidity
  - Locations subject to corrosive gas
  - Locations subject to vibration or mechanical shocks exceeding the rated values
  - Locations subject to exposure to water, oil, chemicals
  - Locations subject to stream
  - Locations subjected to strong magnetic field or electric field
- Do not use in an environment exposed to an inflammable/explosive gas
- Do not use in an ambient atmosphere or environment exceeding the rating.
- Although the product is classified into IP67, do not use it in water, under the rain, or outdoor.
- Do not use the product for any inflammable, explosive, or corrosive fluids.
- Do not froze or solidify the fluid. Otherwise, the product might fail or be damaged.
- Provide a relief valve to prevent the circuit from liquid sealing.
- The surface temperature of the sensing part may increase. Use caution while operating and cleaning the product.
- Make sure safety before installing/replacing the sensor, for example, stop the machine or depressurize the fluid.
- In order to ensure safety of user operations and maintenance, install the product apart from high-pressure equipment or power equipment.
- When revolving the product, support the chassis holding part with a spanner.
- Wire this product separately from high-pressure wire or power wire. If wiring together with such wire or in the same duct, this product might receive induction, which might cause malfunctioning

or damages.

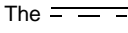
- Be sure to turn OFF the power before wiring.
- Do not wire with a wet hand.
- Use this product under the rated or smaller load. Otherwise, the product might be damaged or catch fire.
- Connect load correctly.
- If the load and sensor use separate power supplies, turn ON the sensor's power first.
- Process unwired terminals so that they do not contact other wire or equipment.
- Do not use the product with the main unit damaged.
- Be careful with the sharp screw parts.
- Do not pull connected cables hard.
- Do not use organic solvents such as thinner or alcohol for cleaning because they deteriorate the degree of protection and indication performance.
- Do not try to disassemble, repair, or alter the main unit.
- If disposing this product, handle it as industrial waste.
- This product is certified by the UL standard based on the assumption that Class 2 circuits are used. Operate this product using Class 2 power supply in the United States or Canada.
- Use cables of Omron model XS5F-D4 series or model XS5W-D4 series.
- The  mark shown on the sensor nameplate means direct current.
- Electromagnetic environment: Industrial electromagnetic environment (EN 61326-1 Table2)

### Precaution for Correct Use

- Do not use this product as a measuring apparatus for commercial transactions.
- Do not use this product for any fluids containing impurities.
- If the fluid is non-conductive and the pipe is made of resin, ground the chassis.
- Use the product in the condition that the fluid temperature is higher than the ambient temperature. For preventing condensation, use the product as dehumidifying by air conditioning and 30 cm or more apart from cold pipes.
- Do not add excessive impart such as falling or collision.
- Do not touch the detecting unit with bare hands.
- Apply grease to the thread parts to prevent them from getting hard to remove due to seizure.
- Fasten by the prescribed torque.
- When using a cable of which diameter is different from that of the recommended cable, prepare a ferrite core suitable for the cable diameter separately.
- If using the product in IO-Link mode, keep the wiring length between the master unit and sensor 20 m or less.
- Just after the power is turned ON, it might take long for the measured value to get stable according to the operating environment.
- Do not connect CH 2 (pin 2) with the IO-Link master unit in analog current output mode. The unit might fail depending on the specification of the IO-Link master.
- Do not push the button with something sharp such as a screwdriver because doing so might damage the button.
- If using the product in an environment subject to sharp temperature variation, evaluate the product in the environment in advance.
- When implementing maintenance, use a soft brush or waste cloth so as not to damage the detecting unit or O-ring.
- When replacing the O-ring, prevent dust/dirt from being mixed into the O-ring.
- Use the product in an environment at altitudes less than 2,000 m.
- Use the product in an environment of pollution degree 3.

## Piping method

- Use the adapter according to the connection pipe diameter of the piping.
- When assembling pipes, use the KITZ's PTZ piping joint (\*1).
- Use a pipe joint whose applicable diameter of the piping side is equal to that of the sensor installation side.  
Because the sensor is designed so that the measurement area is in the center of the piping, correct measurement may not be possible with different diameter fittings.
- Feed the fluid so that the inside of the pipe is filled up with water. Otherwise, measured values might be misaligned or fluctuate.
- When piping, ensure a straight pipe length (\*2) on both upstream and downstream sides. (The measured value may deviate.)
- Mount the product so that the measurement area does not contact the piping wall. (Fig. A)
- Do not mount the product on the downward piping whose lower part is open. (Fig. B)
- In the case of horizontal piping, it is recommended to install the sensor from the side. (Fig. C)
- In the case of vertical piping, it is recommended to install the sensor such that the flow is from the bottom to the top. (Fig. D)
- The chassis holding unit can be revolved along the boundary between itself and body unit.  
When revolving the body unit, support the chassis holding unit with a wrench.
- For both horizontal and vertical piping, install the product with turning the long side of the chassis holding unit to the upstream side of the piping.
- Mount the attached ferrite core at a position located within 10 mm from the edge of the cable bushing when you use this product as CE acceptable goods.

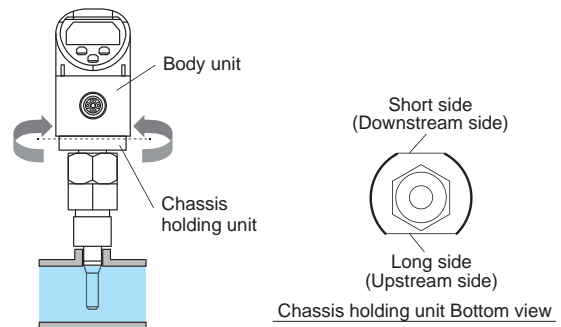
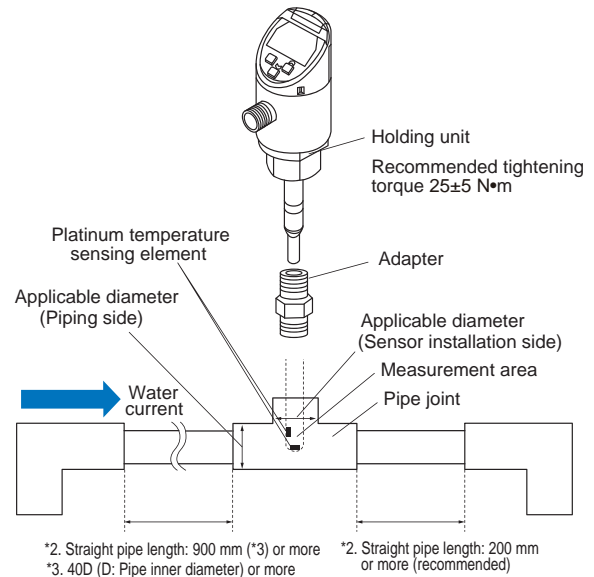
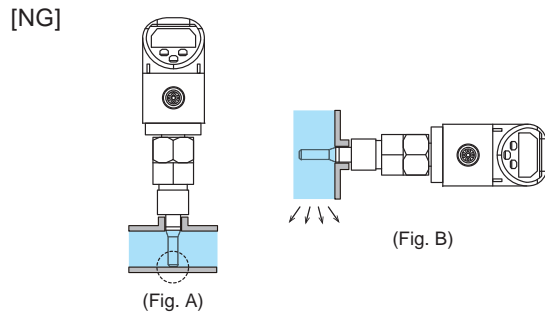
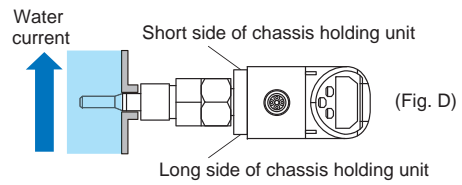
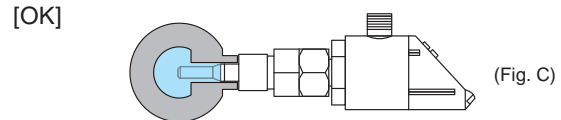

<Dedicated adapter>		*1
E8FC-YA-R10A	E8FC-YA-N10A	<Recommended Pipe joint>
E8FC-YA-R15A	E8FC-YA-N15A	KITZ's
E8FC-YA-R20A	E8FC-YA-N20A	PTZ-10A
E8FC-YA-R25A	E8FC-YA-N25A	PTZ-15A
		PTZ-20A
		PTZ-25A

# Dimensions

## Sensors

### IoT Flow Sensor E8FC-25□

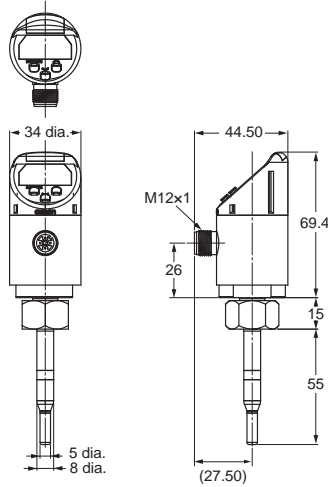

## Adapters

### E8FC-YA-R10A E8FC-YA-N10A

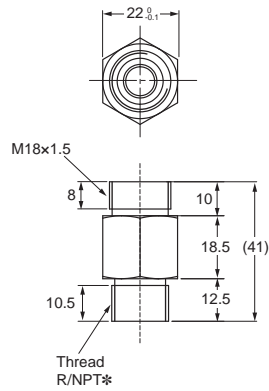

\* The specification for each model is shown in the table below.

Model	E8FC-YA-R10A	E8FC-YA-N10A
Applicable diameter	10 A	
Threaded	R3/8	NPT3/8

### E8FC-YA-R15A E8FC-YA-N15A

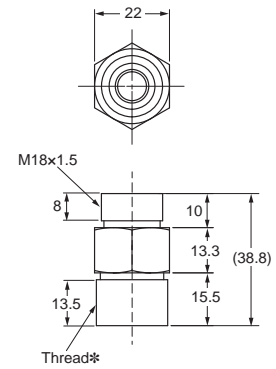

\* The specification for each model is shown in the table below.

Model	E8FC-YA-R15A	E8FC-YA-N15A
Applicable diameter	15 A	
Threaded	R1/2	NPT1/2

### E8FC-YA-R20A E8FC-YA-N20A

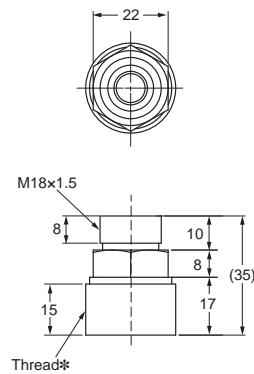

\* The specification for each model is shown in the table below.

Model	E8FC-YA-R20A	E8FC-YA-N20A
Applicable diameter	20 A	
Threaded	R3/4	NPT3/4

### E8FC-YA-R25A E8FC-YA-N25A

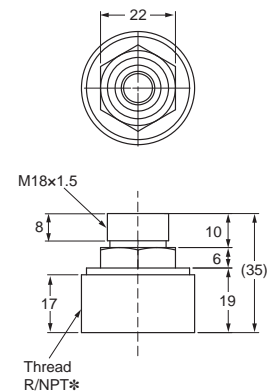

\* The specification for each model is shown in the table below.

Model	E8FC-YA-R25A	E8FC-YA-N25A
Applicable diameter	25 A	
Threaded	R1	NPT1

## O-ring E8FC-YL-1

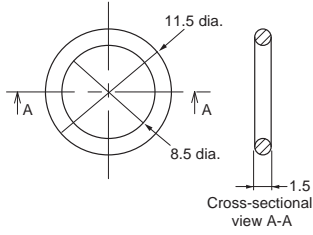

## Cables

### Sensor I/O Connectors (M12, Socket on one cable end)

**Straight**  
XS5F-D421-D80-F  
XS5F-D421-G80-F

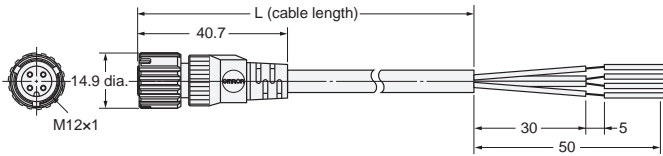

### Sensor I/O Connectors (M12, Socket and plug on cable ends)

**Straight/straight**  
XS5W-D421-D81-F  
XS5W-D421-G81-F

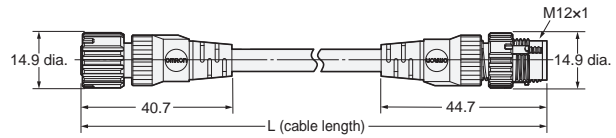

**L-shaped**  
XS5F-D422-D80-F  
XS5F-D422-G80-F

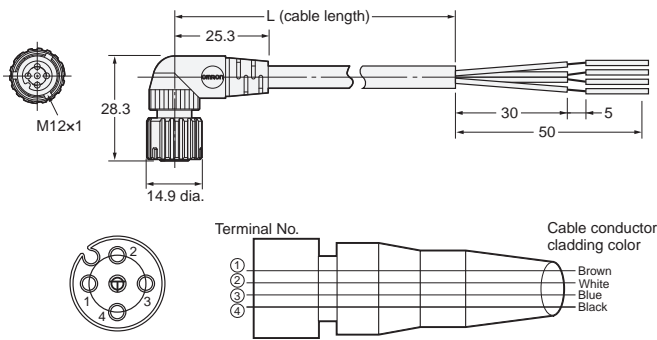

**L-shaped/L-shaped**  
XS5W-D422-D81-F  
XS5W-D422-G81-F

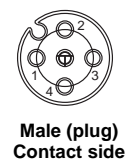
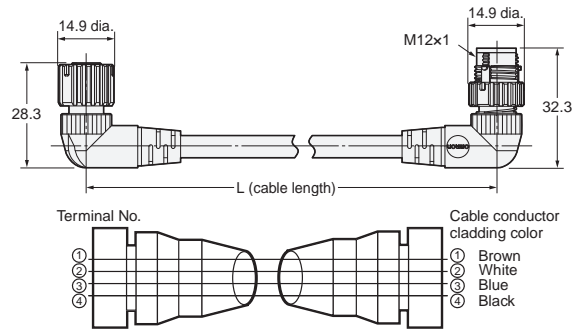

# Terms and Conditions Agreement

## **Read and understand this catalog.**

Please read and understand this catalog before purchasing the products. Please consult your OMRON representative if you have any questions or comments.

## **Warranties.**

(a) Exclusive Warranty. Omron's exclusive warranty is that the Products will be free from defects in materials and workmanship for a period of twelve months from the date of sale by Omron (or such other period expressed in writing by Omron). Omron disclaims all other warranties, express or implied.

(b) Limitations. OMRON MAKES NO WARRANTY OR REPRESENTATION, EXPRESS OR IMPLIED, ABOUT NON-INFRINGEMENT, MERCHANTABILITY OR FITNESS FOR A PARTICULAR PURPOSE OF THE PRODUCTS. BUYER ACKNOWLEDGES THAT IT ALONE HAS DETERMINED THAT THE PRODUCTS WILL SUITABLY MEET THE REQUIREMENTS OF THEIR INTENDED USE.

Omron further disclaims all warranties and responsibility of any type for claims or expenses based on infringement by the Products or otherwise of any intellectual property right. (c) Buyer Remedy. Omron's sole obligation hereunder shall be, at Omron's election, to (i) replace (in the form originally shipped with Buyer responsible for labor charges for removal or replacement thereof) the non-complying Product, (ii) repair the non-complying Product, or (iii) repay or credit Buyer an amount equal to the purchase price of the non-complying Product; provided that in no event shall Omron be responsible for warranty, repair, indemnity or any other claims or expenses regarding the Products unless Omron's analysis confirms that the Products were properly handled, stored, installed and maintained and not subject to contamination, abuse, misuse or inappropriate modification. Return of any Products by Buyer must be approved in writing by Omron before shipment. Omron Companies shall not be liable for the suitability or unsuitability or the results from the use of Products in combination with any electrical or electronic components, circuits, system assemblies or any other materials or substances or environments. Any advice, recommendations or information given orally or in writing, are not to be construed as an amendment or addition to the above warranty.

See <http://www.omron.com/global/> or contact your Omron representative for published information.

## **Limitation on Liability; Etc.**

OMRON COMPANIES SHALL NOT BE LIABLE FOR SPECIAL, INDIRECT, INCIDENTAL, OR CONSEQUENTIAL DAMAGES, LOSS OF PROFITS OR PRODUCTION OR COMMERCIAL LOSS IN ANY WAY CONNECTED WITH THE PRODUCTS, WHETHER SUCH CLAIM IS BASED IN CONTRACT, WARRANTY, NEGLIGENCE OR STRICT LIABILITY.

Further, in no event shall liability of Omron Companies exceed the individual price of the Product on which liability is asserted.

## **Suitability of Use.**

Omron Companies shall not be responsible for conformity with any standards, codes or regulations which apply to the combination of the Product in the Buyer's application or use of the Product. At Buyer's request, Omron will provide applicable third party certification documents identifying ratings and limitations of use which apply to the Product. This information by itself is not sufficient for a complete determination of the suitability of the Product in combination with the end product, machine, system, or other application or use. Buyer shall be solely responsible for determining appropriateness of the particular Product with respect to Buyer's application, product or system. Buyer shall take application responsibility in all cases.

NEVER USE THE PRODUCT FOR AN APPLICATION INVOLVING SERIOUS RISK TO LIFE OR PROPERTY OR IN LARGE QUANTITIES WITHOUT ENSURING THAT THE SYSTEM AS A WHOLE HAS BEEN DESIGNED TO ADDRESS THE RISKS, AND THAT THE OMRON PRODUCT(S) IS PROPERLY RATED AND INSTALLED FOR THE INTENDED USE WITHIN THE OVERALL EQUIPMENT OR SYSTEM.

## **Programmable Products.**

Omron Companies shall not be responsible for the user's programming of a programmable Product, or any consequence thereof.

## **Performance Data.**

Data presented in Omron Company websites, catalogs and other materials is provided as a guide for the user in determining suitability and does not constitute a warranty. It may represent the result of Omron's test conditions, and the user must correlate it to actual application requirements. Actual performance is subject to the Omron's Warranty and Limitations of Liability.

## **Change in Specifications.**

Product specifications and accessories may be changed at any time based on improvements and other reasons. It is our practice to change part numbers when published ratings or features are changed, or when significant construction changes are made. However, some specifications of the Product may be changed without any notice. When in doubt, special part numbers may be assigned to fix or establish key specifications for your application. Please consult with your Omron's representative at any time to confirm actual specifications of purchased Product.

## **Errors and Omissions.**

Information presented by Omron Companies has been checked and is believed to be accurate; however, no responsibility is assumed for clerical, typographical or proofreading errors or omissions.

· Other company names and product names in this document are the trademarks or registered trademarks of their respective companies.

**OMRON Corporation Industrial Automation Company**

Kyoto, JAPAN

Contact: [www.ia.omron.com](http://www.ia.omron.com)

**Regional Headquarters**

**OMRON EUROPE B.V.**

Wegalaan 67-69, 2132 JD Hoofddorp  
The Netherlands

Tel: (31)2356-81-300/Fax: (31)2356-81-388

**OMRON ELECTRONICS LLC**

2895 Greenspoint Parkway, Suite 200  
Hoffman Estates, IL 60169 U.S.A.

Tel: (1) 847-843-7900/Fax: (1) 847-843-7787

**OMRON ASIA PACIFIC PTE. LTD.**

438B Alexandra Road, #08-01/02 Alexandra  
Technopark, Singapore 119968

Tel: (65) 6835-3011/Fax: (65) 6835-2711

**OMRON (CHINA) CO., LTD.**

Room 2211, Bank of China Tower,  
200 Yin Cheng Zhong Road,  
PuDong New Area, Shanghai, 200120, China

Tel: (86) 21-5037-2222/Fax: (86) 21-5037-2200

**Authorized Distributor:**

© OMRON Corporation 2022 All Rights Reserved.  
In the interest of product improvement,  
specifications are subject to change without notice.

**CSM\_1\_1**

**Cat. No. E608-E1-01**

0622 (0622)