

Anywhere in the world

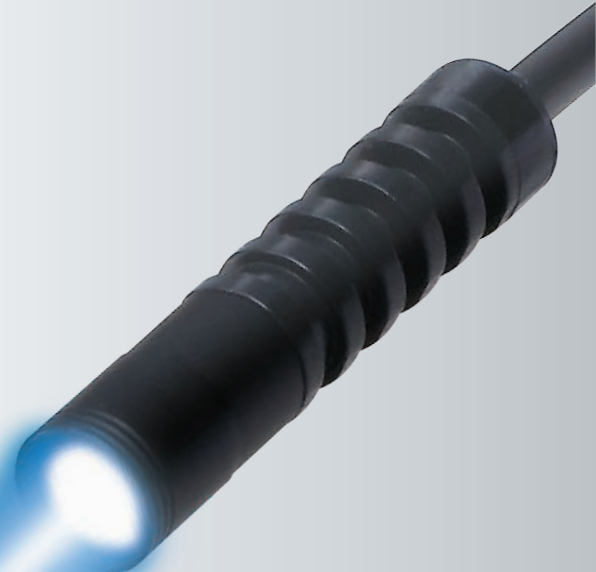

OMRON's "reliability" as the reason for choice

OMRON was among the first in the industry to focus on the LED light source which causes less thermal damage and has less running costs than conventional lamps, and has been offering UV LED curing systems for 17 years (as of 2022). The long-time best seller ZUV Series has been meeting the UV curing needs with the ever-increasing variety of lenses and heads. It offers a long lifetime, significantly reducing operating costs. OMRON provides supply and support worldwide, including Asia Pacific and Greater China, through its global sales network for your peace of mind.



17 years of
global sales
experience^{*1}



Local procurement at overseas factories

Our global sales network of around 150 locations in 40 countries and regions offers reliable supply and support.

..... Page 4

Meeting diverse UV curing needs

Combined with a wide variety of lenses and heads, the ZUV Series satisfies various needs such as UV curing of camera modules and other small parts.

..... Page 6

Long life reducing operating costs

The head can be used for up to 25,000 hours, cutting operating costs.

..... Page 8

*1. Experience of selling the ZUV Series. As of February 2022.

Local procurement at overseas factories

Sales network of around 150 locations in 40 countries and regions

The LEDs mounted on the head unit need to be replaced regularly when their life ends. If you cannot receive support abroad from the manufacturer, you need to procure parts or arrange repairs and troubleshooting as well as regular replacement remotely from your country. This may interfere with local production. OMRON provides the same level of supply and support for the ZUV Series anywhere in the world including Asia Pacific and Greater China. You can reliably use the ZUV Series in overseas factories without compromising productivity and quality.



Cross-border Support – Consultation Desk arranges your service request to be carried out Globally –

OMRON account manager pass your request to our Consultation Desk, which Will allow you to use our technical service without constraints of various procedures, languages and borders.

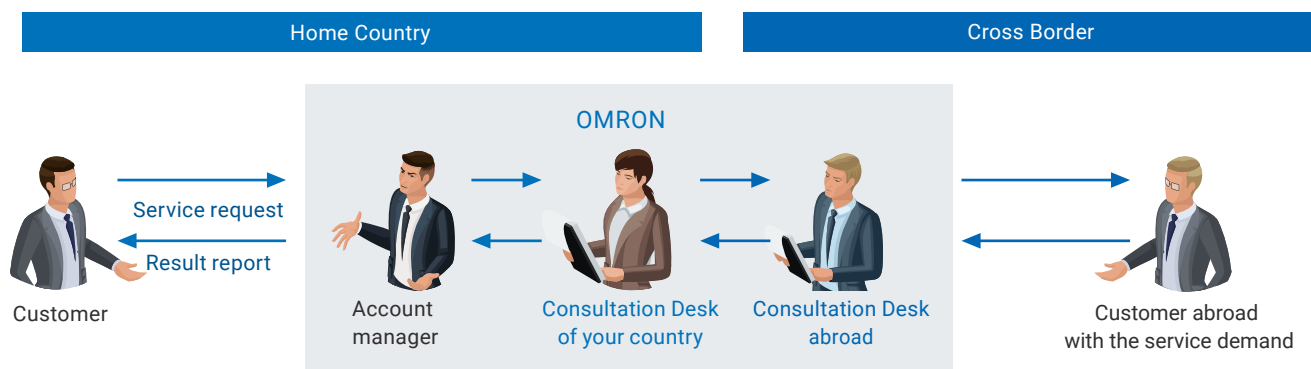

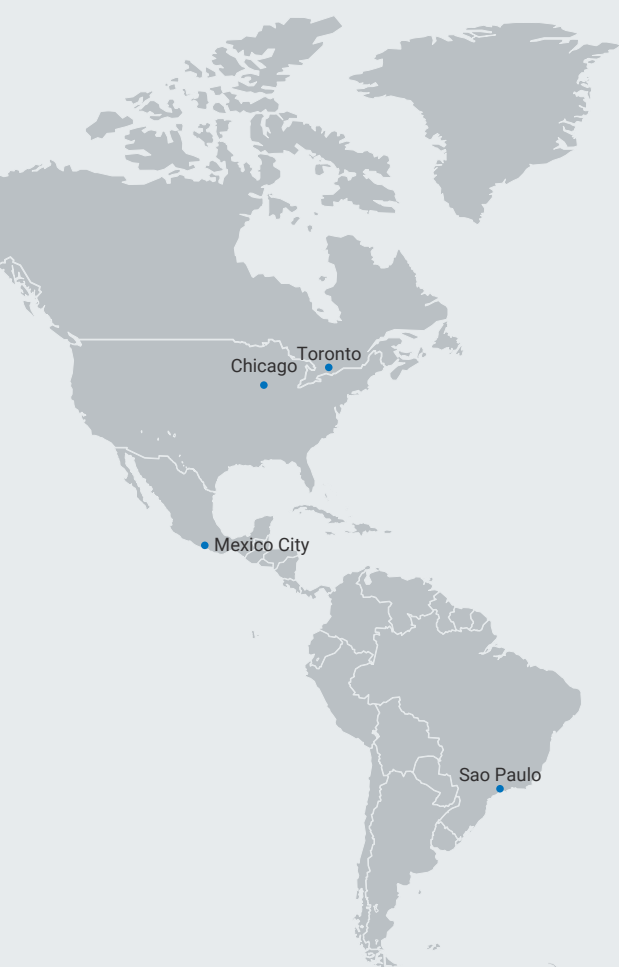

9 Automation Centers in Southeast Asia and Greater China

In Southeast Asia and Greater China where many assembly factories for the world are based, OMRON helps with overseas expansion at its country headquarters and 9 Automation Centers*2 that demonstrate control applications using latest automation devices.



Please visit the OMRON website for the latest information.
https://www.ia.omron.com/global_network

*1. As of March 2020.

*2. 35 Automation Centers are located around the world. As of February 2022.

17 years of experience in providing UV LED curing systems (as of 2022)

OMRON was one of the first to exploit the advantage of the UV LED light source and released its first curing system with UV LEDs which replaced lamp irradiation systems, the ZUV Series, in 2005. With the extended variety of heads, lenses, and controllers, the ZUV Smart Curing System became the most popular curing system with UV LEDs in Japan in 2007.*3 Now in 2022 OMRON is manufacturing the ZUV Series at its own factory and has a proven track record of selling the ZUV Series in various countries around the world since its release in 2005.



Manufactured at OMRON's factory

*3. Based on 2009 LED related market research issued by Fuji Chimera Research Institute, Inc. on March 12, 2009.

Meeting diverse UV curing needs



Five spot sizes for reliable UV bonding

UV irradiation using a standard head and spot lens is recommended for general UV curing. The UV irradiation area size can be changed simply by replacing the head lens. You can choose the best spot size for the workpiece from five lenses with different spot diameters, enabling reliable curing of UV adhesives.

Reduce tact time and footprint by combining lens and head

Line beam lens for large area curing

The lens with a wide beam width provides relatively uniform elliptical irradiation. This enables UV curing of even previously difficult workpieces with a single irradiation.



Diffuse illumination head x diffusing lens for curing at a distance

This combination maintains the irradiation power of 800 mW/cm² for curing even when the head is 30 mm away from the workpiece. This solves the problem that irradiation cannot be performed close to the workpiece.

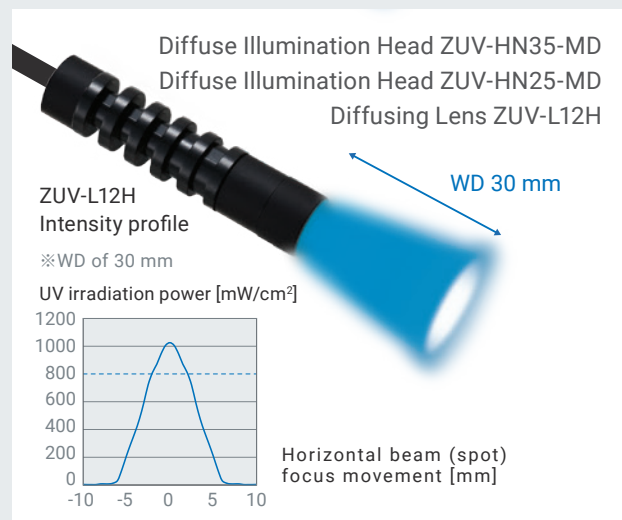

Bonding of camera module housings to substrates

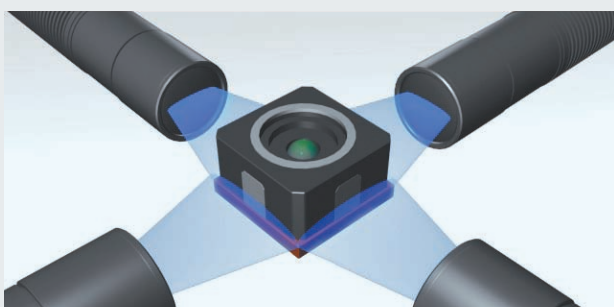

UV curing across a wide area using four heads with the line beam lens reduces tact time.

UV bonding of optical pickup prisms

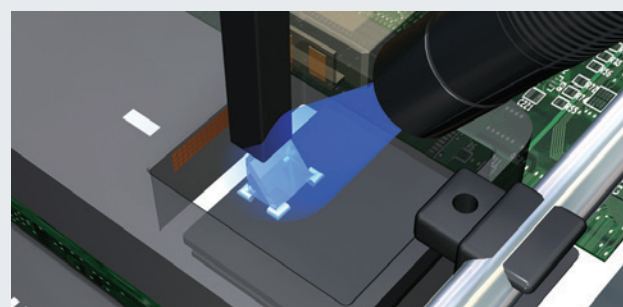

Diffuse beam irradiation enables UV curing with a working distance of 30 mm.

Standard Head
ZUV-HN20MD/ZUV-HN30MD

Spot Lens
ZUV-L3H/L4H/L6H/L8H/L10H

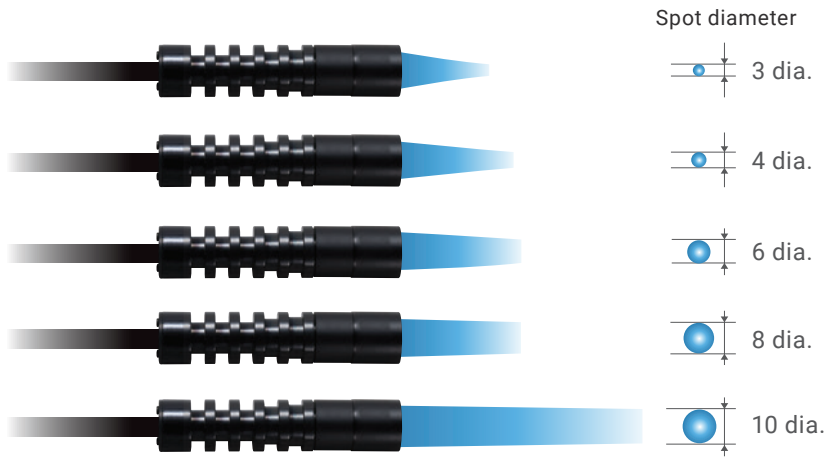

Note: The image of the ZUV-HN20MD.

Ultra light focus lens for quick curing

The use of the ultra light focus lens with a spot diameter of 2 mm achieves maximum irradiation of 13,200 mW/cm²*1. Strong irradiation power allows fast curing.



Ultra Light Focus Lens
ZUV-L2H

Side-view lens for irradiation in small spaces

The head with the lens that delivers irradiation at right angles to the head only needs about 1/7 of the installation space of the standard head with the spot lens. Installation flexibility enables UV irradiation in narrow spaces.



Side-View Lens
ZUV-L3S/L4S/L6S/L8S/L10S

Bonding of needles to syringes

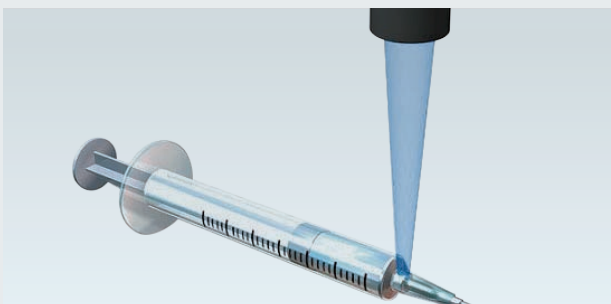

High-speed UV curing with the ultra light focus lens shortens tact time of the bonding process.

*1. Under the following conditions: 100% irradiation power, 25°C room temperature, and with heat sink. Values for reference only.

Minimization of rear space

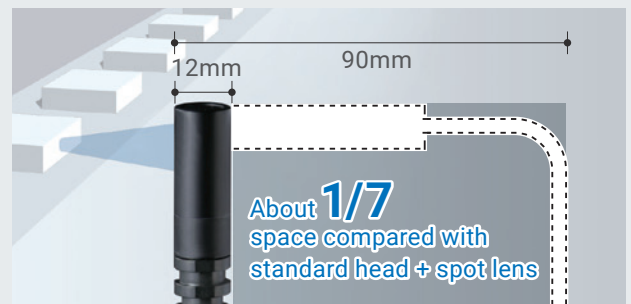

About **1/7** space compared with standard head + spot lens

Installation space of production equipment can be effectively used. This lens is also suited to retrofitting in confined spaces in existing machines.

Long life reducing operating costs

Reduce replacement frequency of light source with unique heat dissipation structure

The life of a UV LED can be shortened if the heat from the LED cannot escape. All the ZUV Heads use OMRON's unique heat dissipation structure to avoid rise in temperature during light emission, having a long life and reducing replacement frequency of their light source.

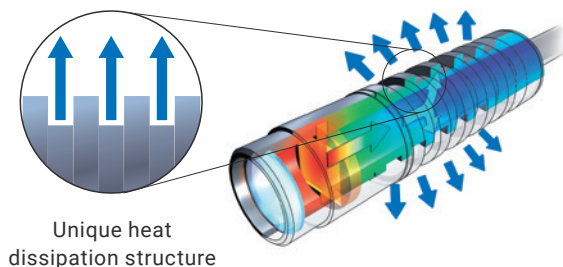

Significantly cut operating costs with ultra cooling head

The ultra cooling head can be used for about 4.6 years which are longer than the standard head, greatly reducing operating costs.

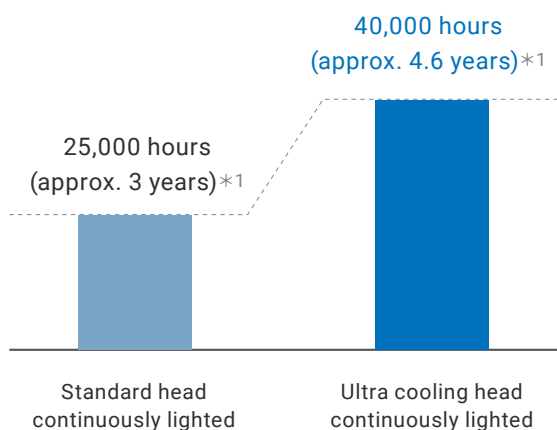

*1. Useful life when operated 24 hours a day (expected life span)
The expected life span is a period until light intensity degradation expected by design calculation under application conditions described in the instruction sheet. Values for reference only.

Long body for super-long life

The ultra cooling head has a long body where the number of heat dissipation ribs was increased from 21 of the ZUV-HN30MD Standard Head to 40. Extensive heat dissipation achieved 1.6 times longer life than the standard head and more stable irradiation intensity.

Heat dissipation comparison between ultra cooling head and standard head

Ultra Cooling Head
ZUV-HN10MD

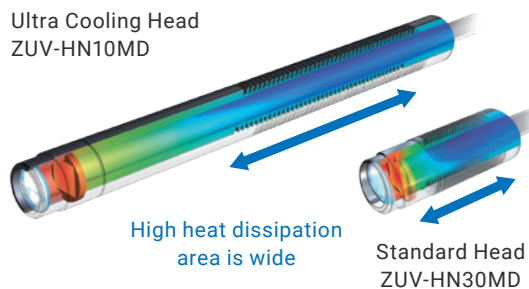

Lower CO₂ emissions through reduced power consumption

The highly stable UV LED light source is designed to save power by turning ON when needed. This can significantly reduce not only electricity costs but also CO₂ emissions, contributing to carbon neutrality. In addition, the LED light source that does not use mercury reduces environmental impact.

Power consumption (per unit) ^{*2}
Approx. 57 W

Annual CO₂ emissions from 100 units ^{*3}
Approx. 4.8 t

CO₂ NEUTRAL

*2. Power consumption may vary depending on device conditions.

*3. It was assumed that the head was operated 24 hours a day for 260 days and ON time/equipment operating time = 1/3. CO₂ emissions were calculated using the receiving end coefficient of 4.1 t/10,000 kWh published by the Federation of Electric Power Companies of Japan.

Excellent functionality and usability facilitate on-site operations

Easy-to-operate LCD display

The LCD display simplifies setting. Since it shows irradiation status during operation, UV curing can be performed without expert skills.

Controller
ZUV-C40H



Setup screen		Screen during operation		
Irradiation time and power can be set on the top screen.	The easy-to-see menu can be displayed in English or Japanese.	Constant irradiation and pattern irradiation, such as pulse irradiation, are possible to reduce resin shrinkage.	Life can be judged from the cumulative energy.	Irradiation power can be adjusted even during operation.

Programmed irradiation from each head

A single controller can independently control four heads. This enables irradiation from different heads with different power, duration, and timing. Irradiation patterns, such as step irradiation and linear irradiation, can be programmed.

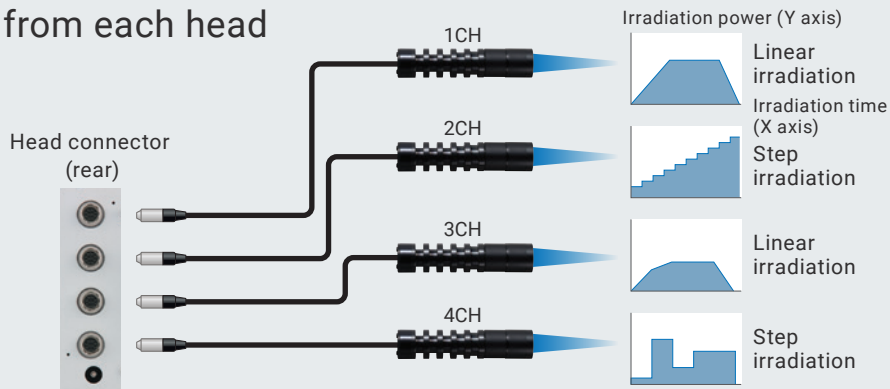

Multi-access link for external control and data transfer

The multi-access link functionality enables external control via the I/O and RS-232C ports and data transfer to a PC via the USB port, providing great usability.

I/O and RS-232C ports	Irradiation log data	Irradiation power compensation
You can control inputs from the external devices via the I/O ports or the RS-232C port to start or stop irradiation, change irradiation patterns, and raise alarms.	The cumulative irradiation energy, counts, and other data can be transferred to a PC via USB. This is useful for storing quality data and analyzing failures.	The Power Tuning function is provided to compensate irradiation power based on the outputs from a luxmeter. Power can be simply compensated during a pre-operation check.

Smart Curing System ZUV Series

Anywhere in the world

- Minimal heat damage thanks to UV-LED irradiation.
- Local procurement at overseas factories *.
- Combined with a wide variety of lenses and heads to meet various curing needs.
- Reduced operating costs with the head with a long life of 25,000 hours.
- Equipped with a color LCD that makes settings simple.

* Our global sales network of around 150 locations in 40 countries (Refer to page 6).



(Standards do not apply to all models.)

Refer to *Safety Precautions* on page 16.

For the most recent information on models that have been certified for safety standards, refer to your OMRON website.

Product Configuration



*1 ZUV-C40H includes an AC adapter. ZUV-C40H-D does not include an AC adapter.

*2 Model is also available with 2-m cable. (ZUV-HN30MD 2M)

*3 Model is also available with 2-m cable. (ZUV-HN10MD 2M)

*4 When using ZUV-HN25MD/HN35MD diffuse illumination head with side-view lens, we recommend using ZUV-L3S/L4S.

- Company names and product names in this document are the trademarks or registered trademarks of their respective companies.
- The product photographs and figures that are used in this catalog may vary somewhat from the actual products.

Ordering Information

Controller *NEW*

Type	Model
Multi-function model	ZUV-C40H
	ZUV-C40H-D

Note: ZUV-C40H includes an AC adapter. ZUV-C40H-D does not include an AC adapter.

Head Unit * *NEW*

Type	Cable length	Model
Standard head	2 m	ZUV-HN20MD 2M
	0.3 m	ZUV-HN30MD 0.3M
Ultra cooling head	0.3 m	ZUV-HN10MD 0.3M
	2 m	ZUV-HN10MD 2M
Diffuse illumination head	2 m	ZUV-HN25MD 2M
	0.3 m	ZUV-HN35MD 0.3M

* 365 - nm light source wavelength. Models are also available with a 385-nm light source wavelength.
(Standard head: ZUV-H21MC 2M/H11MC 2M, diffuse illumination head: ZUV-H26MC 2M) Use with the ZUV-C30H Controller.

Lens Unit

Type	Spot	Model
Spot lens	Spot dia.: 3 mm	ZUV-L3H
	Spot dia.: 4 mm	ZUV-L4H
	Spot dia.: 6 mm	ZUV-L6H
	Spot dia.: 8 mm	ZUV-L8H
	Spot dia.: 10 mm	ZUV-L10H
Ultra light focus lens	Spot dia.: 2 mm	ZUV-L2H
Line beam lens	Beam width: 12 mm	ZUV-L12L
	Beam width: 15 mm	ZUV-L15L
Side-view lens *	Spot dia.: 3 mm	ZUV-L3S
	Spot dia.: 4 mm	ZUV-L4S
	Spot dia.: 6 mm	ZUV-L6S
	Spot dia.: 8 mm	ZUV-L8S
	Spot dia.: 10 mm	ZUV-L10S
Diffusing lens (for diffuse illumination head)	Spot dia.: 12 mm	ZUV-L12H

* When using ZUV-HN25MD/HN35MD diffuse illumination head with side-view lens, we recommend using ZUV-L3S/L4S.

For Extending Length between Controller and Heads

Type	Cable length	Model
Extension cable	2 m	ZUV-XCN02A
	5 m	ZUV-XCN05A
	10 m	ZUV-XCN10A

ZUV Series

Ratings and Specifications

Controller

Item	Model	ZUV-C40H/ZUV-C40H-D
Irradiation method	Constant irradiation	Irradiation power (0 to 100%). irradiation time (max. 999.9 seconds/unlimited)
	Pattern irradiation	Can be set to step or ramp (linear) (16 points specified per setting)
Number of settings		16 banks
Terminal block I/O	Inputs	Emergency stop, Start/stop UV irradiation (4 channels), Select settings (banks)
	Outputs	Ready (4 channels), UV irradiating, errors
RS-232C and USB	Inputs	Start/stop UV irradiation (4 channels), select settings (banks), get/change setting data, save/read data, execute power tuning, get cumulative irradiation energy
	Outputs	
Cooling method		Natural air cooling
Applicable Head Unit		ZUV-HN□□
Applicable Extension Cable		ZUV-XCN□□
Power supply voltage		Select AC or DC power supply. <ul style="list-style-type: none"> AC power supply: 100 to 240 VAC ±10%, 50/60 Hz (AC adapter supplied) *1 *2 DC power supply: 24 VDC ±10% (supplied from the terminal block on rear of unit)
Current consumption		<ul style="list-style-type: none"> With AC adapter: 1.5 A (36 VA) With DC power supply: 1.5 A (36 VA)
Vibration resistance		10 to 150 Hz: acceleration: 50 m/s ² single amplitude: 0.35 mm each of the X, Y and Z directions for 8 minutes. 10 times
Drop impact resistance		150 m/s ² each in 6 directions (up/down, left/right, forward/backward), for 3
Ambient temperature range		Operating: 5 to 35°C, Storage: -10 to 60°C (with no condensation or icing)
Ambient humidity range		Operating/storage: 30% to 85% (with no condensation or icing)
Degree of protection		IEC60529 IP20
Material		SECC, aluminum
Weight (packed state)		Approx. 2600 g (main unit: Approx. 1800 g)
Accessories		Instruction Sheet, key, AC adapter (Not for ZUV-C40H-D)

*1. Attached AC cord as standard is designed for use with 100 VAC (Japanese specifications). Please purchase ZUV-C40H-D for use outside Japan.

*2. In the case that you use ZUV-C40H in other than Japan, please connect DC power supply to terminal on backside.

Head Unit

Item	Model	ZUV-HN20MD	ZUV-HN25MD	ZUV-HN10MD		ZUV-HN30MD		ZUV-HN35MD
Length		2 m		2 m	0.3 m	2 m	0.3 m	0.3 m
Light source	Wave length	365 nm *						
Applicable Controller		ZUV-C40H(-D)						
Applicable Extension Cable		ZUV-XCN□□						
Vibration resistance		10 to 150 Hz, Acceleration: 50 m/s ² , Single amplitude: 0.35 mm in X, Y, and Z directions, 10 sweeps each (8 min/sweep)						
Shock resistance		150 m/s ² in 6 directions (+/-X, +/-Y, and +/-Z directions), 3 times each						
Ambient temperature range		Operating: 5 to 35°C, Storage: -10 to 60°C (with no condensation or icing)						
Ambient humidity range		Operating/storage: 30% to 85% (with no condensation or icing)						
Degree of protection		IEC 60529 IP40						
Materials		Aluminum, glass, zinc		Aluminum, glass, zinc, copper				
Weight (in packing)		Approx. 185 g (main unit: approx. 100 g)		Approx. 235 g (main unit: approx. 160 g)	Approx. 180 g (main unit: approx. 105 g)	Approx. 185 g (main unit: approx. 100 g)	Approx. 150 g (main unit: approx. 55 g)	
Accessories		Instruction sheet (this sheet), mounting brackets (with M3 screws), warning labels (in English)						

* Models are also available with a 385-nm light source wavelength. (Standard head: ZUV-H21MC 2M/H11MC 2M, diffuse illumination head: ZUV-H26MC 2M) Use with the ZUV-C30H Controller.

Lens Unit

Model	ZUV-L2H/L3H/L4H/L6H/L8H/L10H/L12L/L15L/L3S/L4S/L6S/L8S/L10S/L12H
Vibration resistance	10 to 150 Hz (acceleration 50 m/s ²) with a 0.35 mm single amplitude for 8 minutes each in X, Y, and Z directions, 10 times
Shock resistance	150 m/s ² , in 6 directions (up/down, right/left, front/back), 3 times each
Ambient temperature range	Operating: 5 to 35°C; Storage: -10 to 60°C (with no condensation or icing)
Ambient humidity range	Operating/storage: 30% to 85% (with no condensation or icing)
Degree of Protection	IEC60529 IP40
Material	Aluminum, glass
Weight (package)	ZUV-L2H/L3H/L4H/L6H/L8H/L10H: Approx. 10g (Lens unit: approx. 5g), ZUV-L12L/L15L : Approx. 30g (Lens unit: approx. 5g), ZUV-L3S/L4S/L6S/L8S/L10S : Approx. 35g (Lens unit: approx. 5g), ZUV-L12H : Approx. 30g (Lens unit: approx. 5g)
Accessories	Instruction sheet

When using the standard head

Ultra light focus lens/Spot lens/Line beam lens

Head unit model	ZUV-HN20MD/HN30MD/HN10MD						
Lens unit model	ZUV-L2H	ZUV-L3H	ZUV-L4H	ZUV-L6H	ZUV-L8H	ZUV-L10H	ZUV-L12L
Spot diameter/Beam shape	2 dia.	3 dia.	4 dia.	6 dia.	8 dia.	10 dia.	12 × 2 mm
Recommended working distance	10 mm	10 mm	15 mm	20 mm	20 mm	30 mm	15 mm
Max irradiation *1	13,200 mW/cm ²	8,600 mW/cm ²	7,200 mW/cm ²	4,500 mW/cm ²	2,200 mW/cm ²	760 mW/cm ²	1,500 mW/cm ²

Side-view lens

Head unit model	ZUV-HN20MD/HN30MD/HN10MD				
Lens unit model	ZUV-L3S	ZUV-L4S	ZUV-L6S	ZUV-L8S	ZUV-L10S
Spot diameter	3 dia.	4 dia.	6 dia.	8 dia.	10 dia.
Recommended working distance	4 mm	5 mm	8 mm	13 mm	5 mm
Max irradiation *1	8,300 mW/cm ²	6,400 mW/cm ²	4,200 mW/cm ²	2,100 mW/cm ²	660 mW/cm ²

When using the diffuse illumination head

Diffusing lens/Side-view lens/Line Beam lens

Head unit model	ZUV-HN25MD/HN35MD			
Lens unit model	ZUV-L12H	ZUV-L3S	ZUV-L4S	ZUV-L15L
Spot diameter/Beam shape	12 dia.	3 dia.	4 dia.	15 × 3 mm
Recommended working distance	30 mm	8 mm	13 mm	15 mm
Max irradiation *1	1,100 mW/cm ²	5,400 mW/cm ²	3,000 mW/cm ²	770 mW/cm ²

*1. Under the following conditions: 100% irradiation power, 25°C room temperature, and with heat sink. Values for reference only.

The irradiation varies depending on factors such as the ambient environment, installation conditions, the service life of part, and differences between parts.

Continually check the curing status to ensure that there is room for error in the irradiation.

Refer to *Beam Spot Profiles (Typical Examples)* on page 14 to 15 for design information.

ZUV Series

Engineering Data (Reference Value)

Beam Spot Profiles (Typical Examples)

Standard head /ultra cooling head (Controller ZUV-C40H, at 100% irradiation power)

Ultra light focus lens ZUV-L2H Intensity profile

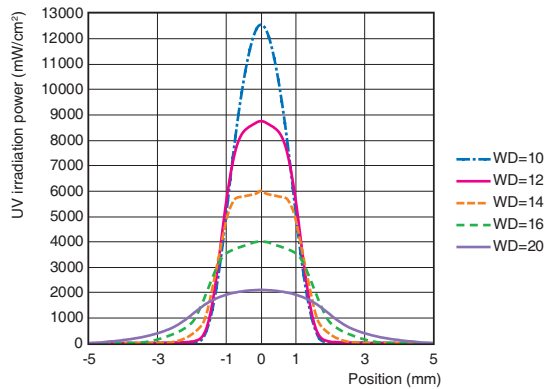

Spot lens ZUV-L3H Intensity profile

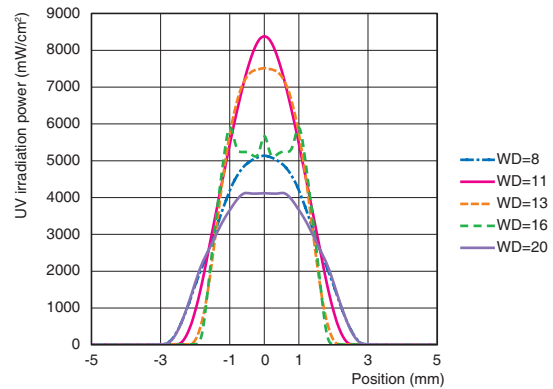

Spot lens ZUV-L4H Intensity profile

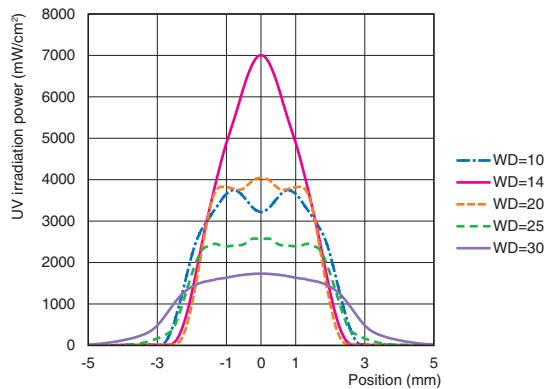

Spot lens ZUV-L6H Intensity profile

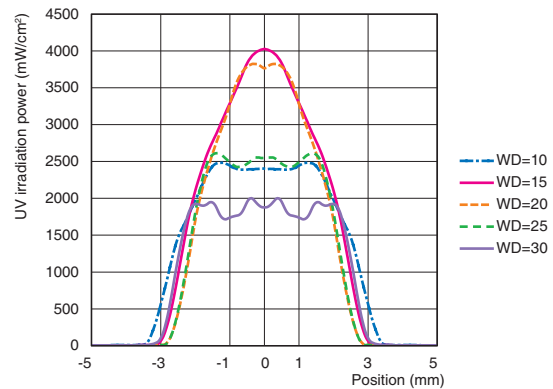

Spot lens ZUV-L8H Intensity profile

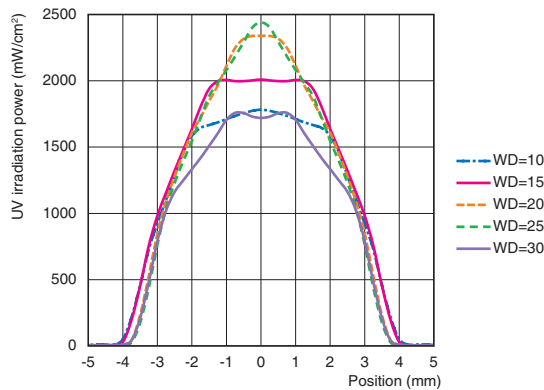

Spot lens ZUV-L10H Intensity profile

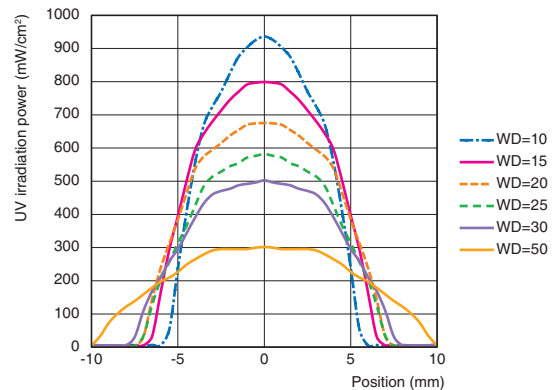

Side-view lens ZUV-L3S Intensity profile

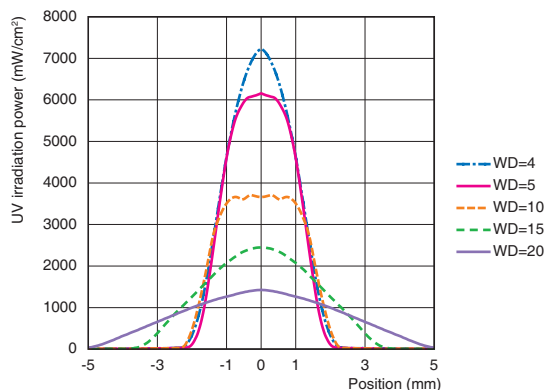

Side-view lens ZUV-L4S Intensity profile

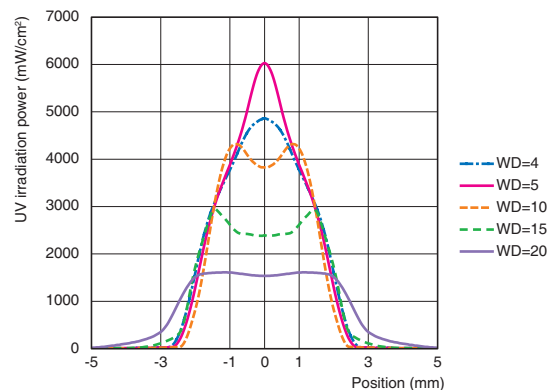

Note: 1. WD is setting distance to a workpiece from a lens unit end face.

2. The intensity profile varies depending on factors such as the ambient environment, installation conditions, the service life of part, and differences between parts. Continually check the curing status of the resin to ensure that there is room for error in the intensity profile.

Side-view lens ZUV-L6S Intensity profile

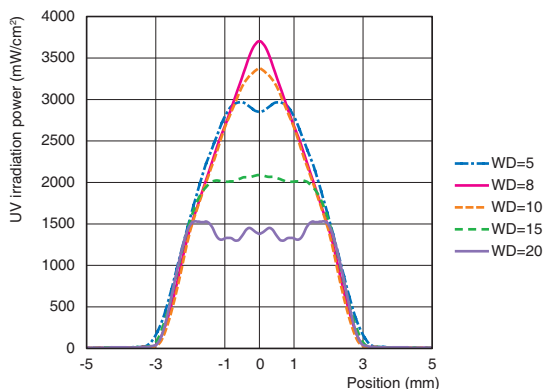

Side-view lens ZUV-L8S Intensity profile

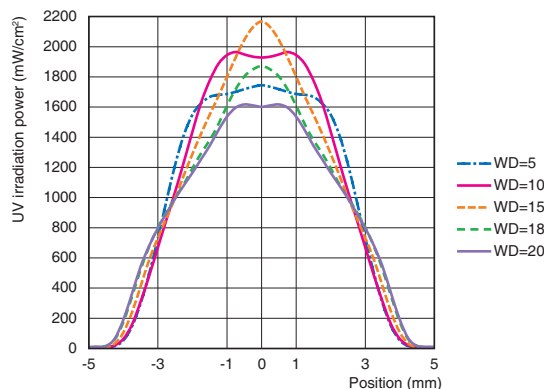

Side-view lens ZUV-L10S Intensity profile

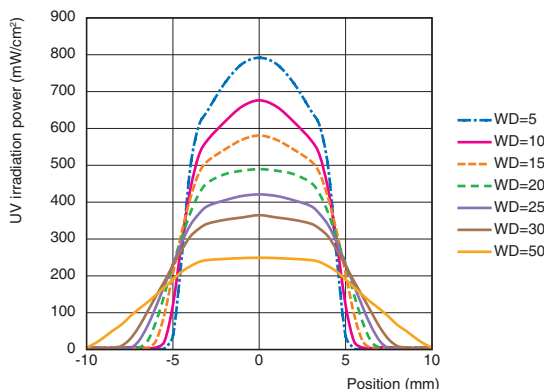

Line beam lens ZUV-L12L Intensity profile (length direction)

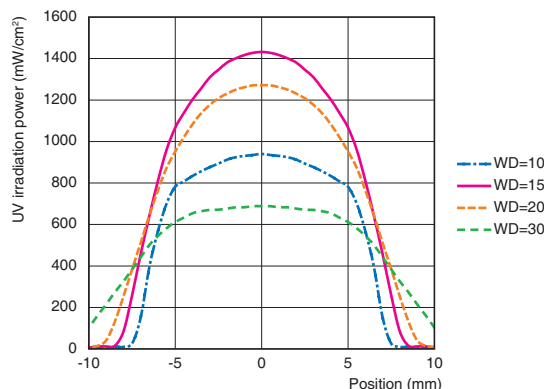

Line beam lens ZUV-L12L Intensity profile (width direction)

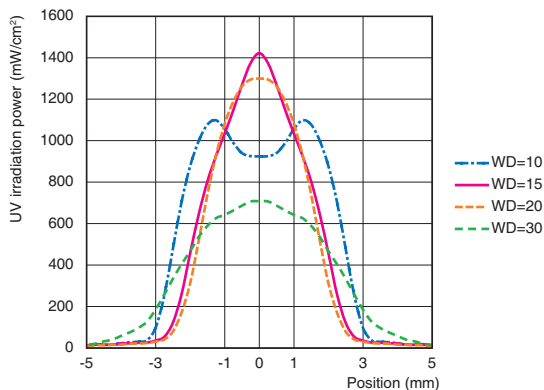

Diffuse illumination head ZUV-HN25MD/HN35MD (Controller ZUV-C40H, at 100% irradiation)
Diffusing lens ZUV-L12H Intensity profile

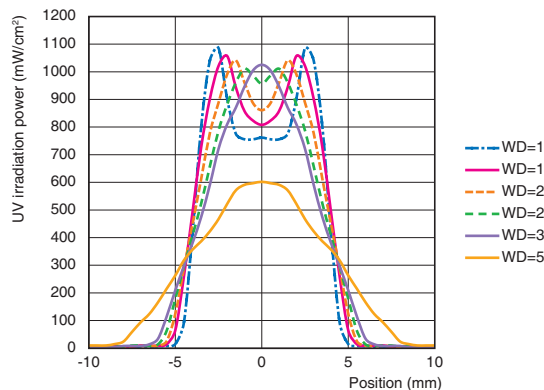

Line beam lens ZUV-L15L Intensity profile (length direction)

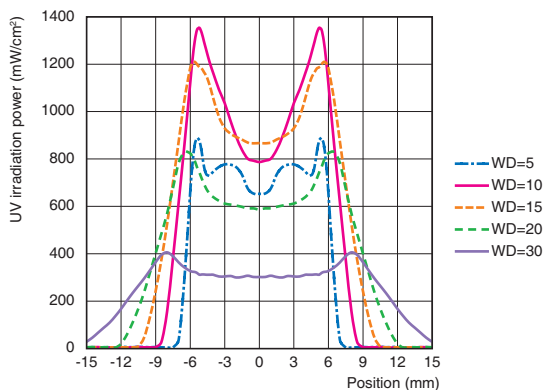

Line beam lens ZUV-L15L Intensity profile (width direction)

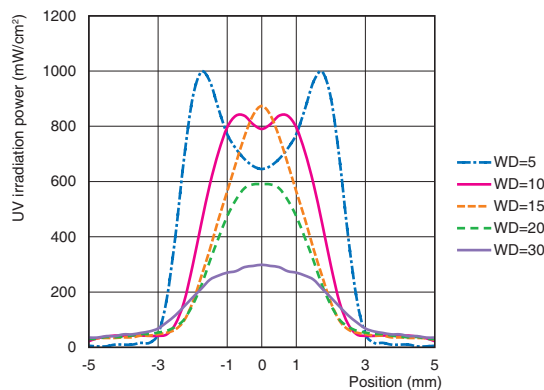

Note: 1. WD is setting distance to a workpiece from a lens unit end face.
2. The intensity profile varies depending on factors such as the ambient environment, installation conditions, the service life of part, and differences between parts. Continually check the curing status of the resin to ensure that there is room for error in the intensity profile.

Safety Precautions

Refer to Warranty and Limitation of Liability.

Controller

Warning Indications

Precautions for Safe Use	Supplementary comments on what to do or avoid doing, to use the product safely.
Precautions for Correct Use	Supplementary comments on what to do or avoid doing, to prevent failure to operate, malfunction or undesirable effect on product performance.

PRECAUTIONS FOR SAFE USE

Observe the following precautions to ensure safe operation.

1. Do not use the product in environments where it can be exposed to inflammable/explosive gas.
2. To ensure safety of operation and maintenance, do not install the product close to high-voltage devices and power devices.
3. When using an AC power supply, use the AC adaptor (supplied with the product, 100 to 240 VAC \pm 10%).
4. When using a DC power supply, the supply voltage must be within the rated range (24 VDC \pm 10%). In addition, reverse connection of the power supply is not allowed. Recommended power source: S8VS-18024 (24 VDC 7.5 A) by OMRON
5. Open-collector outputs should not be short-circuited.
6. Use the power supply within the rated load.
7. High-voltage lines and power lines must be wired separately from this product.
Wiring them together or placing them in the same duct may cause induction, resulting in malfunction or damage.
8. Should you notice any abnormalities such as smoke, abnormal heat of the product surface, and/or any foul odor, immediately stop use, turn OFF the power supply, and disconnect the power plug from the outlet. Contact your OMRON representative for repair of the product. Repairing it by yourself may cause danger.
9. Do not attempt to dismantle, repair, or modify the product. Doing so may cause the product to not operate correctly as well as cause a malfunction resulting in a fire or an electric shock.
10. Dispose of this product as industrial waste.
11. Do not drop the product.
If the product is dropped or damaged, turn OFF the power supply, disconnect the powerplug from the outlet, and contact your OMRON representative. Using it continuously without repair may cause a fire.
12. Do not insert any foreign objects into the product through the ventilation hole or any other opening. Doing so may cause a fire or electric shock.
13. Do not install multiple controllers close to others, or do not pile them up. Doing so may cause a fire or breakdown of the product.

PRECAUTIONS FOR CORRECT USE

- Do not install the product in locations subjected to the following
 - Ambient temperature outside the rating
 - Rapid temperature fluctuations (causing condensation)
 - Relative humidity outside the range of 30 to 85%
 - Presence of corrosive or flammable gases
 - Presence of dust, salt, or iron particles
 - Direct vibration or shock
 - Reflection of intense light (such as other UV lights, laser beams, or electric arc-welding machines)
 - Direct sunlight or near heaters
 - Water, oil, or chemical fumes or spray, or mist environment
 - Strong magnetic or electric field
- Power Supply and Wiring
 - When using a controller, make sure that the FG terminal on the main unit is grounded.
 - When using a DC power supply, make sure that the power source is grounded.
 - When using a DC power supply, observe the following points:
 - When using a commercially available switching regulator, make sure that the FG terminal is grounded.
 - If surge currents are present in the power lines, connect surge absorbers that suit the operating environment.
 - Before turning ON the power after the product is connected, make sure that the power supply voltage is correct, there are no incorrect connections (e.g. load short-circuit) and the load current is appropriate.
 - A third party product is used for the AC adapter (LTE90E-SW-306 by Li Tone Electronics Co., LTD).
 - The attached cable for the AC adapter can only be used in Japan. It cannot be used in other countries.
 - When using the AC adapter, connect the power plug into the controller before inserting the power cord into an outlet.
 - When removing the AC adapter, unplug the power cord from the outlet before removing the power plug from the controller.
 - Before connecting/disconnecting the head, make sure that the controller is turned OFF.
 - Use only combinations of the head and controller, extension cable specified in this manual.
 - The exclusive extension cable can be used between head and controller. However, do not use multiple extension cables for conjunction use.
- Cleaning
 - Do not use paint thinner, benzene, acetone, or kerosene for cleaning since these solutions dissolve the product surface.
 - Use commercially available alcohol.
 - To remove dirt or dust particles from the lens, wipe gently with a soft cloth (for cleaning lenses) moistened with a small amount of alcohol.
- About Resin Hardening

The hardening state of resin varies depending on various factors. Check the hardening state of resin on an ongoing basis and set the optimum conditions.
- Replacing the Head

When replacing the head, be sure to initialize the target channel on the controller.

If the target channel is not initialized, the information (cumulative irradiation energy, power tuning data) of the head before replacement may still remain and prevent normal functioning of the head.
- Connecting the Head

When removing and re-connecting the head, be sure to connect to the same channel. If the head is connected to a different channel, information (cumulative irradiation energy, power tuning data) specific to the head is not inherited, preventing the head from functioning normally.

7. LED safety measures

- If a mirror-surface object stands in the light path, install a light shielding cover to the object. When using the product without termination, avoid to set the light at the eye level.
- Although the safety distance, Nominal Ocular Hazard Distance (NOHD) is 1 m, terminate the light path where possible. Termination material with less reflective and lusterless painted surface is the best choice.
- When not using the product, turn OFF the product key and remove it.
- When installing or adjusting the head part, wear protection glasses.

8. Combinations of the head and controller, extension cable

When using, connect with the following combinations. If different combinations, the head connection will not be recognized and can not irradiate UV light.

Controller : ZUV-C40H(-D)

Head Unit : ZUV-HN□□

Extension Cable : ZUV-XCN□□

If "POW" and "TIME" of the target CH are displayed as "---" on the CH SET screen, the head is not recognized for connection. Check if the connection head type is ZUV-HN series.

Installing the controller

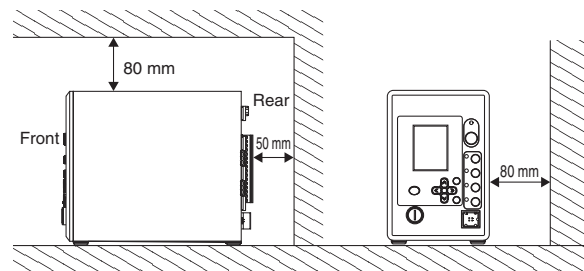

For heat dissipation, leave more space than the dimensions shown below.

ZUV-C40H/ZUV-C40H-D





Head Unit

Warning Indications

 WARNING	Warning level Indicates a potentially hazardous situation which, if not avoided, will result in minor or moderate injury, or may result in serious injury or death. Additionally there may be significant property damage.
 CAUTION	Caution level Indicates a potentially hazardous situation which, if not avoided, may result in minor or moderate injury or in property damage.
Precautions for Safe Use	Supplementary comments on what to do or avoid doing, to use the product safely.
Precautions for Correct Use	Supplementary comments on what to do or avoid doing, to prevent failure to operate, malfunction or undesirable effect on product performance.

Meaning of Product Safety Symbols

	General caution Indicates unspecified general alert
	Disassembly prohibited Prohibit the disassembly of a device because of the possibility of injuries due to electric shock.
	Caution, high temperature Indicates the possibility of injuries by high temperature under specific conditions.

WARNING

Direct exposure of eye or skin to ultraviolet light will damage eyesight or the skin. Never look into or expose the body to the ultraviolet light. Work wearing protection glasses and protection equipment if exposure to the reflected ultraviolet light is considered.



Electric shock or leaked light may cause injury or damage to the product. Never disassemble the product.



CAUTION

Touching the product may result in burns. Do not touch the product while energized or immediately after turning OFF the power supply.



PRECAUTIONS FOR CORRECT USE

- Avoid installing the product in the following places:
 - Places exposed to strong electromagnetic fields
 - Places where the lens in front of the head may be exposed to dust, oil, or dew condensation.
 - Places subject to corrosive gases
 - Places where the product is exposed to direct shock or vibration.
- Wiring
 - Keep the cable between the head and the controller away from high-voltage cables or power lines. If laid in the same duct, induction noise from them may cause malfunction or breakdown of the product.
 - Use only combinations of the head and controller, extension cable specified in this manual.
 - Be sure to turn OFF the power supply when mounting or demounting the head part.
 - An extension cable can be used between head and the controller. Do not use extended multiple cables.
- Cleaning
 - Avoid the use of thinner, benzene, acetone, and kerosene. Use of these solvents will melt the surface of the product.
 - Use commercially available alcohol.
 - Wipe out small dirt or dust carefully not to damage the lens using a soft cloth (such as a lens cleaner) containing a small quantity of alcohol.
- Resin cure

State of resin cure changes depending on various factors. Continuously check the state of resin cure to set at the best condition.
- Mounting of the head

Make sure to use attached mounting bracket for the head part. Use the bracket within the specified mounting range. Misuse of the mounting bracket may raise the temperature rise of the head and shorten the usage life of LED.
- Combinations of the head and controller, extension cable

When using, connect with the following combinations. If different combinations, the head connection will not be recognized and can not irradiate UV light.

Controller: ZUV-C40H(-D)
 Head Unit: ZUV-HN□□
 Extension Cable: ZUV-XCN□□

Applicable standards

- EN61326-1
- Electromagnetic environment:
Industrial electromagnetic environment
(EN/IEC 61326-1 Table 2)

PRECAUTIONS FOR SAFE USE

Observe the following precautions to ensure safe operation.

- Do not use the product in atmospheres containing flammable or explosive gases.
- Do not try to disassemble, repair, or modify this product.
- Dispose of this product as industrial waste.
- Do not touch the head lens for a long time during ultraviolet light irradiation. Doing so may result in burns.
- Do a special medical check-up, based on "Notice No.308" of Ministry of Health, Labour and Welfare, for workers handling this product.
- Be sure to use the attached mounting bracket to fix the head part. Use the bracket within the specified mounting range. Misuse of the mounting bracket may raise the head temperature, causing burns.
- A long time exposure of the UV light will give a thermal damage to a target.

Dimensions

Controller

Multi-function model
ZUV-C40H/
ZUV-C40H-D

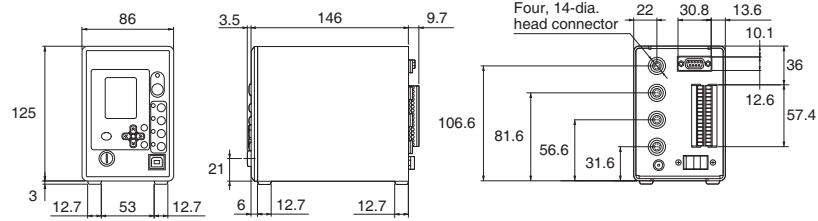

Head Unit

Standard head (When attached to spot lens)

ZUV-HN20MD

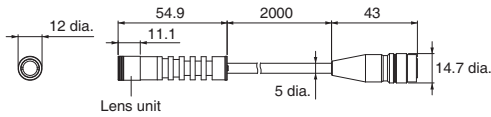

ZUV-HN30MD

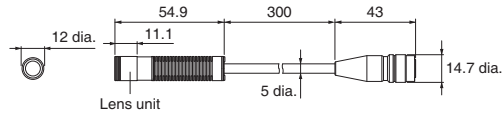

Mounting Bracket

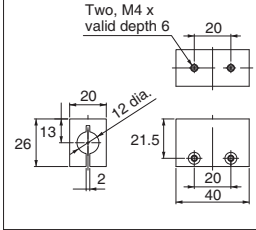

Ultra cooling head

ZUV-HN10MD

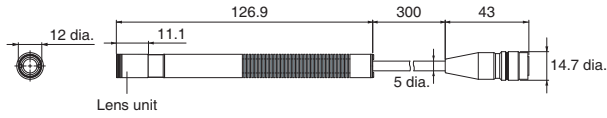

Diffuse illumination head (When attached to ZUV-L12H)

ZUV-HN25MD

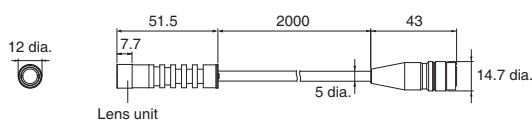

ZUV-HN35MD

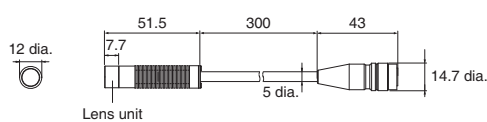

Lens Unit

Spot lens ZUV-L3H/L4H/L6H/L8H/L10H

Note: The model number is printed on the side of the Lens unit.

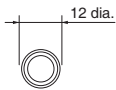

ZUV-L3H/L4H/L6H/L8H

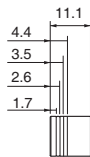

ZUV-L10H

Ultra light focus lens ZUV-L2H

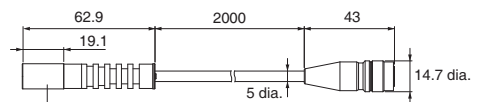
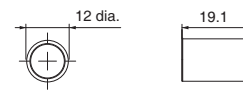

Note: When attached to ZUV-HN20MD (Standard head)

Line beam lens ZUV-L12L

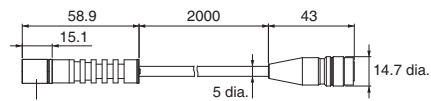
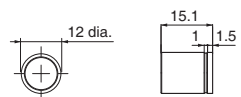

Note: When attached to ZUV-HN20MD (Standard head)

ZUV-L15L

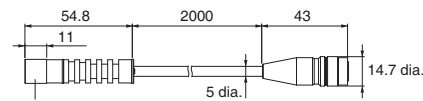
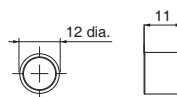

Note: When attached to ZUV-HN25MD (Diffuse illumination head)

Side-view lens ZUV-L□S

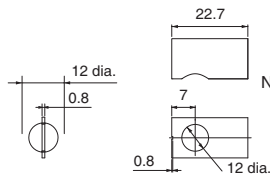

Note: The model number is printed on the side of the lens unit.

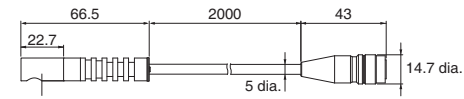

Note: When attached to ZUV-HN20MD (Standard head)

Diffusing lens ZUV-L12H

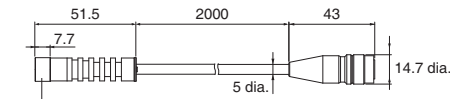
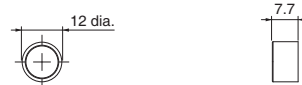

Note: When attached to ZUV-HN25MD (Diffuse illumination head)

Terms and Conditions Agreement

Read and understand this catalog.

Please read and understand this catalog before purchasing the products. Please consult your OMRON representative if you have any questions or comments.

Warranties.

(a) Exclusive Warranty. Omron's exclusive warranty is that the Products will be free from defects in materials and workmanship for a period of twelve months from the date of sale by Omron (or such other period expressed in writing by Omron). Omron disclaims all other warranties, express or implied.

(b) Limitations. OMRON MAKES NO WARRANTY OR REPRESENTATION, EXPRESS OR IMPLIED, ABOUT NON-INFRINGEMENT, MERCHANTABILITY OR FITNESS FOR A PARTICULAR PURPOSE OF THE PRODUCTS. BUYER ACKNOWLEDGES THAT IT ALONE HAS DETERMINED THAT THE PRODUCTS WILL SUITABLY MEET THE REQUIREMENTS OF THEIR INTENDED USE.

Omron further disclaims all warranties and responsibility of any type for claims or expenses based on infringement by the Products or otherwise of any intellectual property right. (c) Buyer Remedy. Omron's sole obligation hereunder shall be, at Omron's election, to (i) replace (in the form originally shipped with Buyer responsible for labor charges for removal or replacement thereof) the non-complying Product, (ii) repair the non-complying Product, or (iii) repay or credit Buyer an amount equal to the purchase price of the non-complying Product; provided that in no event shall Omron be responsible for warranty, repair, indemnity or any other claims or expenses regarding the Products unless Omron's analysis confirms that the Products were properly handled, stored, installed and maintained and not subject to contamination, abuse, misuse or inappropriate modification. Return of any Products by Buyer must be approved in writing by Omron before shipment. Omron Companies shall not be liable for the suitability or unsuitability or the results from the use of Products in combination with any electrical or electronic components, circuits, system assemblies or any other materials or substances or environments. Any advice, recommendations or information given orally or in writing, are not to be construed as an amendment or addition to the above warranty.

See <http://www.omron.com/global/> or contact your Omron representative for published information.

Limitation on Liability; Etc.

OMRON COMPANIES SHALL NOT BE LIABLE FOR SPECIAL, INDIRECT, INCIDENTAL, OR CONSEQUENTIAL DAMAGES, LOSS OF PROFITS OR PRODUCTION OR COMMERCIAL LOSS IN ANY WAY CONNECTED WITH THE PRODUCTS, WHETHER SUCH CLAIM IS BASED IN CONTRACT, WARRANTY, NEGLIGENCE OR STRICT LIABILITY.

Further, in no event shall liability of Omron Companies exceed the individual price of the Product on which liability is asserted.

Suitability of Use.

Omron Companies shall not be responsible for conformity with any standards, codes or regulations which apply to the combination of the Product in the Buyer's application or use of the Product. At Buyer's request, Omron will provide applicable third party certification documents identifying ratings and limitations of use which apply to the Product. This information by itself is not sufficient for a complete determination of the suitability of the Product in combination with the end product, machine, system, or other application or use. Buyer shall be solely responsible for determining appropriateness of the particular Product with respect to Buyer's application, product or system. Buyer shall take application responsibility in all cases.

NEVER USE THE PRODUCT FOR AN APPLICATION INVOLVING SERIOUS RISK TO LIFE OR PROPERTY OR IN LARGE QUANTITIES WITHOUT ENSURING THAT THE SYSTEM AS A WHOLE HAS BEEN DESIGNED TO ADDRESS THE RISKS, AND THAT THE OMRON PRODUCT(S) IS PROPERLY RATED AND INSTALLED FOR THE INTENDED USE WITHIN THE OVERALL EQUIPMENT OR SYSTEM.

Programmable Products.

Omron Companies shall not be responsible for the user's programming of a programmable Product, or any consequence thereof.

Performance Data.

Data presented in Omron Company websites, catalogs and other materials is provided as a guide for the user in determining suitability and does not constitute a warranty. It may represent the result of Omron's test conditions, and the user must correlate it to actual application requirements. Actual performance is subject to the Omron's Warranty and Limitations of Liability.

Change in Specifications.

Product specifications and accessories may be changed at any time based on improvements and other reasons. It is our practice to change part numbers when published ratings or features are changed, or when significant construction changes are made. However, some specifications of the Product may be changed without any notice. When in doubt, special part numbers may be assigned to fix or establish key specifications for your application. Please consult with your Omron's representative at any time to confirm actual specifications of purchased Product.

Errors and Omissions.

Information presented by Omron Companies has been checked and is believed to be accurate; however, no responsibility is assumed for clerical, typographical or proofreading errors or omissions.

Note: Do not use this document to operate the Unit.

OMRON Corporation Industrial Automation Company

Kyoto, JAPAN

Contact: www.ia.omron.com

Regional Headquarters

OMRON EUROPE B.V.

Wegalaan 67-69, 2132 JD Hoofddorp
The Netherlands
Tel: (31)2356-81-300/Fax: (31)2356-81-388

OMRON ELECTRONICS LLC

2895 Greenspoint Parkway, Suite 200
Hoffman Estates, IL 60169 U.S.A.
Tel: (1) 847-843-7900/Fax: (1) 847-843-7787

OMRON ASIA PACIFIC PTE. LTD.

438B Alexandra Road, #08-01/02 Alexandra
Technopark, Singapore 119968
Tel: (65) 6835-3011/Fax: (65) 6835-2711

OMRON (CHINA) CO., LTD.

Room 2211, Bank of China Tower,
200 Yin Cheng Zhong Road,
PuDong New Area, Shanghai, 200120, China
Tel: (86) 21-5037-2222/Fax: (86) 21-5037-2200

Authorized Distributor:

© OMRON Corporation 2022 All Rights Reserved.
In the interest of product improvement,
specifications are subject to change without notice.

CSM_1_1
Cat. No. E607-E1-01

0422 (0422)